



LONGBOARD®
ARCHITECTURAL PRODUCTS

Exterior

Privacy Beams Soffit

Installation Guidelines

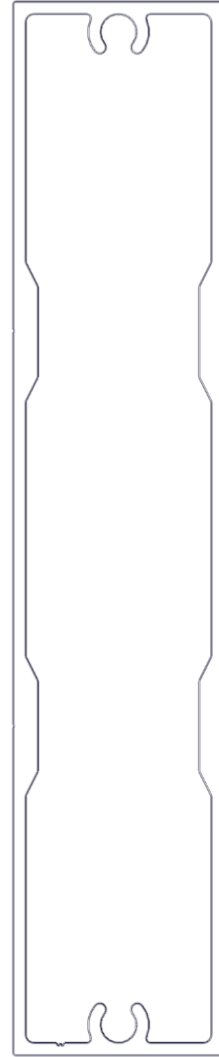
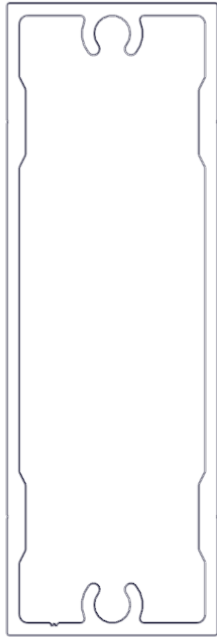

1.0. GENERAL

1.1. Product Description

Longboard® Privacy Beams Privacy Screen is an extruded aluminum open joint privacy screen system, designed to be installed as a screening device attached to a structure or set in ground as a freestanding element. Available in Floating or End-Frame Systems, in beam sizes of 1"x3" (25.4mm x 76.2mm) and 1"x5" (25.4mm x 127mm) and standard lengths of 24' (7.3m). End Caps with a matching finish are used to close off the ends of the Beams of the Floating System. Longboard Privacy Beams Privacy Screen can be installed directly to a post structure or outboard of a UV barrier or building envelope & wall finish.

1.2. Installation Considerations

Depth of system (measured from substrate to finished face):

Floating System using Single Posts = 2-7/16" (63mm)

End-Frame System = 2-1/8" (54mm)

(See Appendix to access profile drawings)

Longboard Products are not recommended for use on marine applications in direct contact with salt water.

1.3. Cutting

⚠ Always be sure to wear appropriate PPE: eye & hearing protection.

Use standard wood-cutting tools such as a miter saw with a carbide blade (60-80 tooth) for non-ferrous metals (aluminum).

Trim the taped/punched ends of all stock length material by 1/2" (12mm) each end and discard (see 1.5.).

1.4. Fastening

Where mounting the system to a substrate; predrill screw locations through the back of the Single Posts every 6' (1.83m) o.c. (max.) with a single drilled hole at the center length of the posts (to limit migration of the posts during thermal expansion/contraction* and double drill and slot all other fastener locations to allow for thermal movement* (see drawing on next page).

Mount Single Posts to the substrate (into stud framing or HSS/wood posts or similar) using #12 sharp-point (for wood substrates) or self-drilling (for metal substrates) zinc-plated or other corrosion resistant screws (not included). Fastener types such as Pan Head, Hex Head or Truss Head are recommended. Posts should be placed at a maximum spacing of 6' (1.83m) o.c.

⚠ All fasteners should be suitable for exterior use and be compatible with the substrate type.

**See table 1 & 2 to calculate the thermal movement for your project, to ensure adequate allowances have been made.*

⚠ At the time of installation, consider the current temperature as it relates to the expected annual high and low range, to place the fasteners at the slotted holes at either the:

- + center of the slot (at average annual)
- + toward end of post (colder than average annual)
- + toward the center of the post (warmer than average annual)

Example: winter typically experiences lows of -20°C (-4°F), summer typically experiences highs of +30°C (86°F) and it is +5°C (41°F) at the time of installation: Place fasteners at the center of the slotted holes. Ensure all fasteners are anchored into solid-secure material or posts.

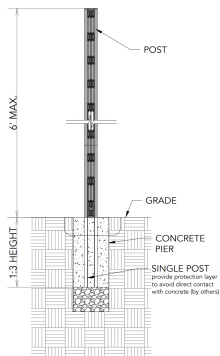
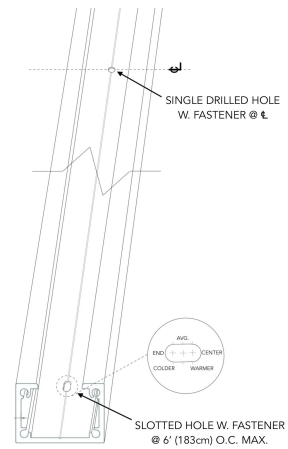

Where installing the posts as a freestanding element, set posts below grade using poured in place concrete following a 3:1 ratio (above grade:below grade) to a maximum height of 6' (1.83m). Eg: 6' (1.83m) above grade requires 2' (0.61m) set below grade (see drawing). Protect the posts from direct contact with the concrete by use of a bitumen paint or similar coating or wrap. Posts should be placed at a maximum spacing of 6' (1.83m) o.c.

1.4.1. Expansion & Contraction

In most climate zones, Privacy Beams Privacy Screen will expand & contract 1/4" (6mm) over 24' (7.3m) measured over a 30°C (54°F) temperature range*.

*See table 1 & 2 to calculate the thermal movement for your project.

Floating System Beams in areas greater than 24' (7.3m) in length, should be installed with staggered butt-joints, leaving a 1/4" (6mm)(min.) gap between the ends of each length, every 24' (7.3m) or less (see Detail A).

See **3. System Installation** for layout details and table 1 & 2 for expansion & contraction calculations per foot/meter of material.

Detail A: BUTT-JOINTS

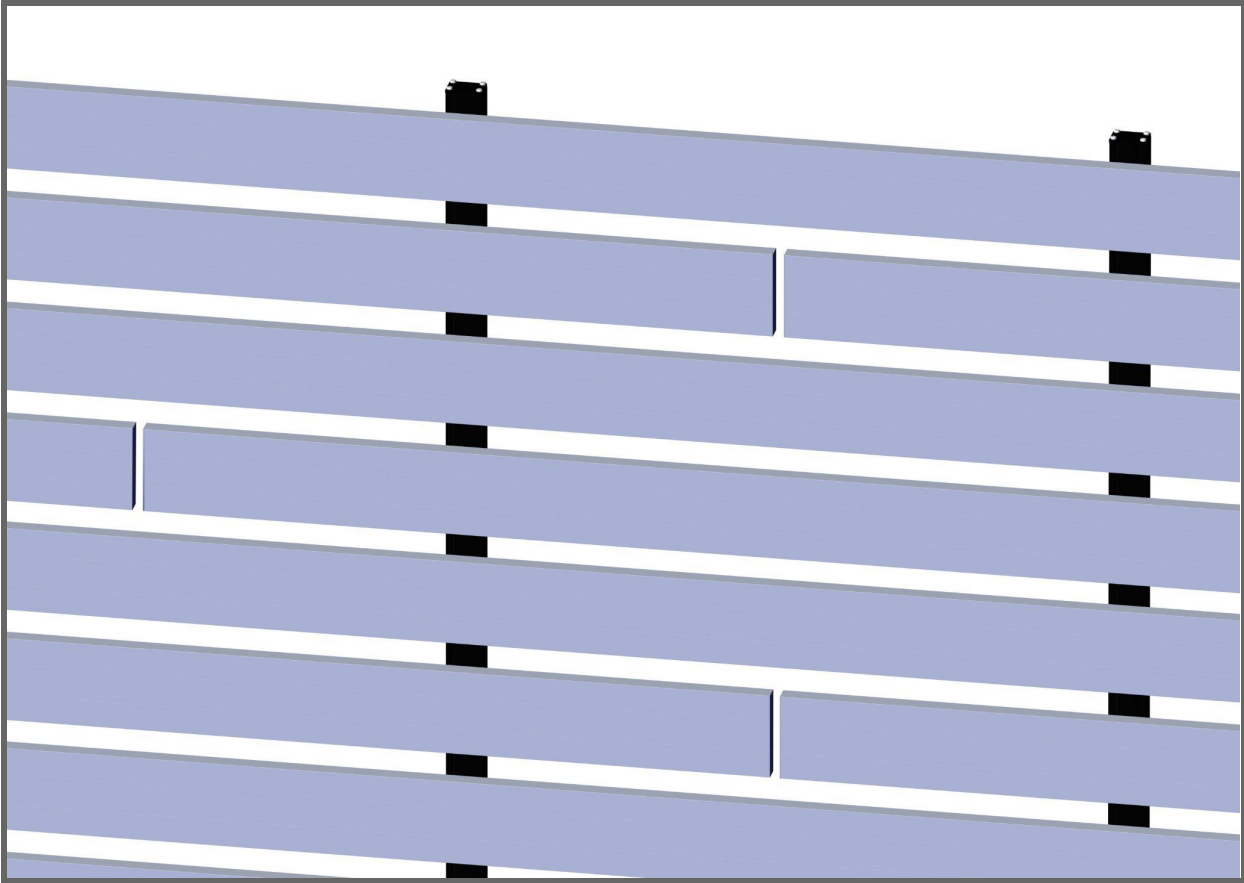

TABLE 1 & 2: MATERIAL THERMAL MOVEMENT RELATING TO AMBIENT TEMPERATURE

TABLE 1 - IMPERIAL

		AVERAGE TEMPERATURE AT TIME OF CUTTING & INSTALLATION											
		°C	-50	-40	-30	-20	-10	0	10	20	30	40	50
		°F	-58	-40	-22	-4	14	32	50	68	86	104	122
MIN/MAX POST CONSTRUCTION TEMP.	°C	°F	EXPANSION OR CONTRACTION (INCH/FOOT)										
	-50	-58	0.000	-0.003	-0.005	-0.008	-0.011	-0.014	-0.016	-0.019	-0.022	-0.024	-0.027
	-40	-40	0.003	0.000	-0.003	-0.005	-0.008	-0.011	-0.014	-0.016	-0.019	-0.022	-0.024
	-30	-22	0.005	0.003	0.000	-0.003	-0.005	-0.008	-0.011	-0.014	-0.016	-0.019	-0.022
	-20	-4	0.008	0.005	0.003	0.000	-0.003	-0.005	-0.008	-0.011	-0.014	-0.016	-0.019
	-10	14	0.011	0.008	0.005	0.003	0.000	-0.003	-0.005	-0.008	-0.011	-0.014	-0.016
	0	32	0.014	0.011	0.008	0.005	0.003	0.000	-0.003	-0.005	-0.008	-0.011	-0.014
	10	50	0.016	0.014	0.011	0.008	0.005	0.003	0.000	-0.003	-0.005	-0.008	-0.011
	20	68	0.019	0.016	0.014	0.011	0.008	0.005	0.003	0.000	-0.003	-0.005	-0.008
	30	86	0.022	0.019	0.016	0.014	0.011	0.008	0.005	0.003	0.000	-0.003	-0.005
	40	104	0.024	0.022	0.019	0.016	0.014	0.011	0.008	0.005	0.003	0.000	-0.003
50	122	0.027	0.024	0.022	0.019	0.016	0.014	0.011	0.008	0.005	0.003	0.000	

TABLE 2 - METRIC

		AVERAGE TEMPERATURE AT TIME OF CUTTING & INSTALLATION											
		°C	-50	-40	-30	-20	-10	0	10	20	30	40	50
		°F	-58	-40	-22	-4	14	32	50	68	86	104	122
MIN/MAX POST CONSTRUCTION TEMP.	°C	°F	EXPANSION OR CONTRACTION (MM/METER)										
	-50	-58	0.000	-0.230	-0.460	-0.690	-0.920	-1.150	-1.380	-1.610	-1.840	-2.070	-2.300
	-40	-40	0.230	0.000	-0.230	-0.460	-0.690	-0.920	-1.150	-1.380	-1.610	-1.840	-2.070
	-30	-22	0.460	0.230	0.000	-0.230	-0.460	-0.690	-0.920	-1.150	-1.380	-1.610	-1.840
	-20	-4	0.690	0.460	0.230	0.000	-0.230	-0.460	-0.690	-0.920	-1.150	-1.380	-1.610
	-10	14	0.920	0.690	0.460	0.230	0.000	-0.230	-0.460	-0.690	-0.920	-1.150	-1.380
	0	32	1.150	0.920	0.690	0.460	0.230	0.000	-0.230	-0.460	-0.690	-0.920	-1.150
	10	50	1.380	1.150	0.920	0.690	0.460	0.230	0.000	-0.230	-0.460	-0.690	-0.920
	20	68	1.610	1.380	1.150	0.920	0.690	0.460	0.230	0.000	-0.230	-0.460	-0.690
	30	86	1.840	1.610	1.380	1.150	0.920	0.690	0.460	0.230	0.000	-0.230	-0.460
	40	104	2.070	1.840	1.610	1.380	1.150	0.920	0.690	0.460	0.230	0.000	-0.230
50	122	2.300	2.070	1.840	1.610	1.380	1.150	0.920	0.690	0.460	0.230	0.000	

1.5. Surface Finish

The Longboard Privacy Beams Privacy Screen system is available in a range of Woodgrain, Solid & Specialty Finishes with custom* solid colors available upon request. **Additional lead times apply.* Longboard Woodgrains have a repeat pattern: stagger each beam approx. 1-2' (305-610mm) from the previous set to achieve a random pattern aesthetic.

All Longboard Products are produced 1" (25mm) oversized, as one end is hole-punched (all finishes) and both ends have 1/2" (12mm) of masking tape (woodgrains only) which must be cut off for best results.



1.6. Material Ordering & Delivery

Items are purchased in lengths/qtys as follows:

24' (7.3m) lengths:

- 1x3 & 1x5 Beams
- Single Posts & Double Posts

12' (3.7m) lengths:

- Spacer Bar* (for custom spacings, floating system) *to be cut to suit on site

20 pcs/bx:

- 1x3 & 1x5 Beam End Caps
- Single Post & Double Post End Caps

100 pcs/bx:

- Spacer Bars - 1" (25.4mm) (floating system)
- Spacer Blocks - 1" (25.4mm) (end-frame system)
- Mounting Brackets (floating system) includes #10 x 3/4" hex drive (bit size: 5/16") SS 410
- Post End Cap Screws - #10 - 1" pan-head black oxide

Lead time is 3-4 weeks* (**subject to change*), delivered on 24' (7.3m) long skids weighing up to 2000 lbs. A mechanical lift with forks is required on site to receive the order.

⚠ Always inspect the delivery for damage and contact LB ASAP if there are any issues: info@longboardproducts.com or 1-800-604-0343 and include your PO# and any pictures if possible. Mark the delivery receipt as "damaged" and accept the delivery as-is. Longboard is not responsible for the installation of blemished or damaged material.

1.7. Storage & Handling

Be sure to store the material flat, keep it dry, safe & secure and remain in unopened cartons until ready to be installed. Ensure proper care when handling, to avoid damage on site.

2.0. FRAMING REQUIREMENTS

2.1. General

Always consult the local building authority and follow local building code requirements.

2.2. Load Capacity

The Longboard Privacy Beams Privacy Screen system weighs approx. 0.7 up to 1.1 lbs/LF* of 1x3 or 1x5 beams.

**see profile drawings for individual item weights.*

2.3.1. Wood-Framing

Traditional stud wall framed at 16" (406mm) o.c. with or without solid secure blocking located at post attachment locations (see 1.4.), exterior wall sheathing, weather resistive barrier (wrp), wall finish or UV barrier. Privacy Beam posts are to be anchored into studs or solid secure blocking.

2.3.2. Metal Framing

16ga. (minimum) galvanized steel framing at 16" (406mm) o.c. with or without solid secure blocking located at post attachment locations (see 1.4.), exterior wall sheathing, wrp, wall finish or UV barrier. Privacy Beam posts are to be anchored into studs or solid secure blocking.

2.3.3. CMU/Concrete

Provide a separation layer such as bitumen paint or impregnated paper, to prevent direct contact between the posts and cmu/concrete. Use concrete anchors (provided by others) of an appropriate size to support the loading at each fastener.

2.3.4. Posts & Other Structures

Solid, secure structure of material designed to support loading (see 2.2.), spaced at 6' (1.83m) o.c. max.

2.3.5. Freestanding system only (no structure)

Base plates for posts are available, for installations to a maximum height of 3' (914mm).

Available for Single Post, Double Post & Corner Posts (two single posts at 90°), sold individually.

3.0. SYSTEM INSTALLATION

3.1. Layout

Measure and layout your privacy area to consider alignment with fixtures, openings and adjacent walls, for desired appearance. If utilizing posts by others, place these at 6' (1.83m) o.c. maximum.

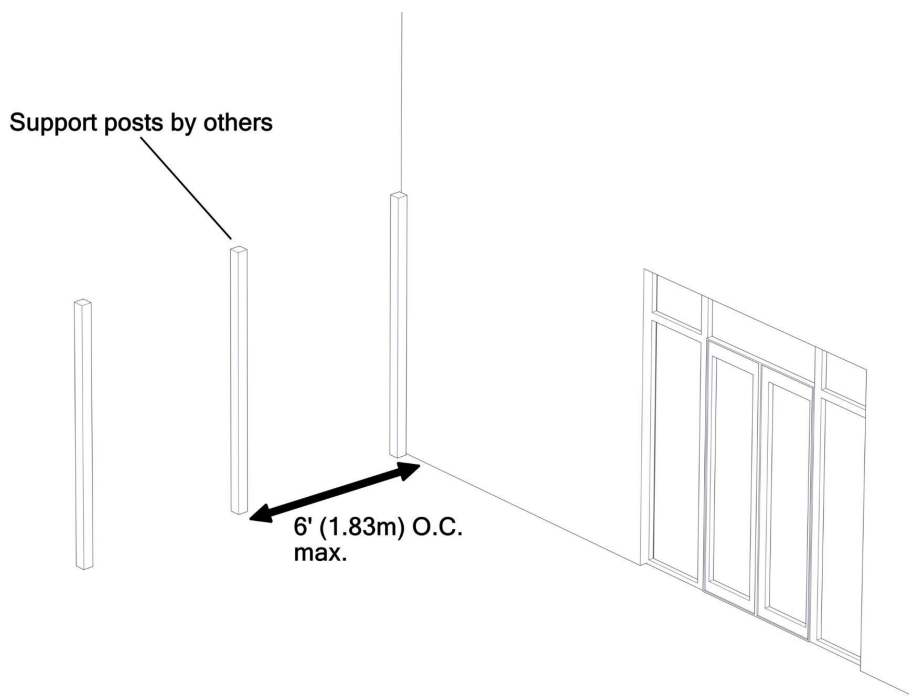
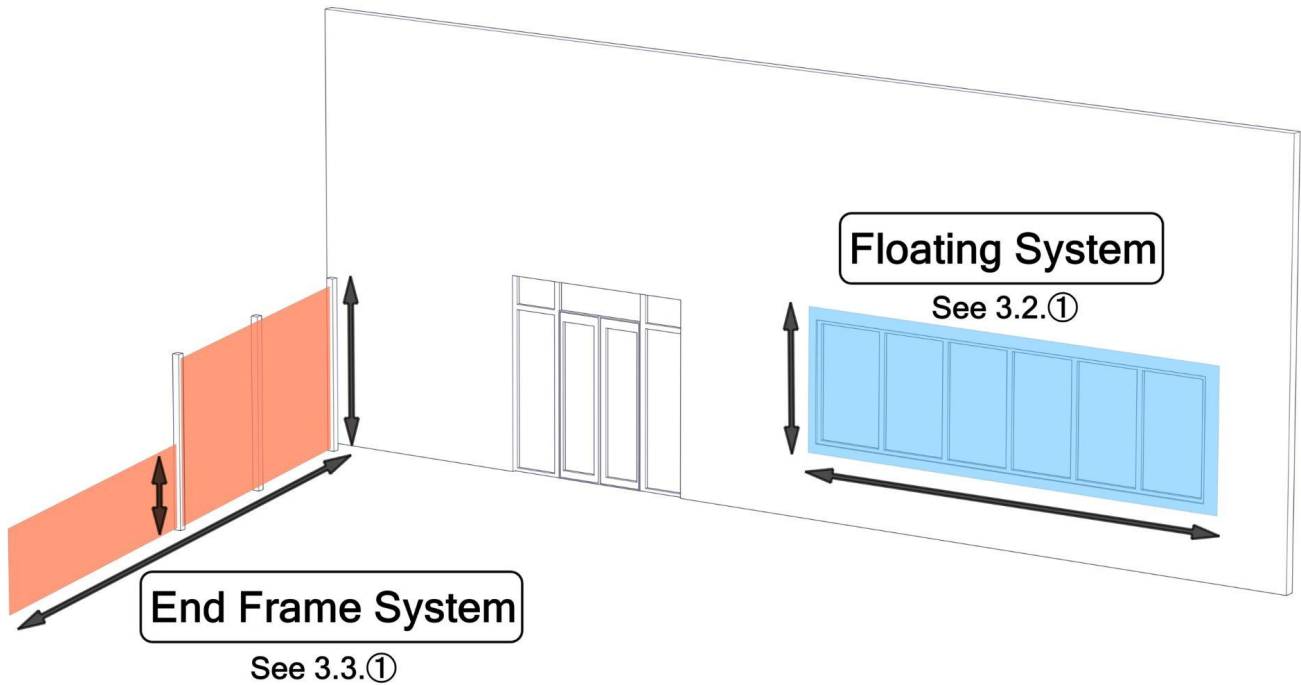

3.2. Installation

Privacy Beams should be installed with staggered butt-joints in applications with longer lengths, leaving a 1/4" (6mm)(minimum) gap between each member to allow for expansion & contraction. See 1.4.1.Expansion & Contraction.

-----FLOATING SYSTEM-----

3.2.①. SINGLE POSTS

Install Single Posts every 6' (1.83m) max, mechanically fastened to the substrate (fasteners not included).

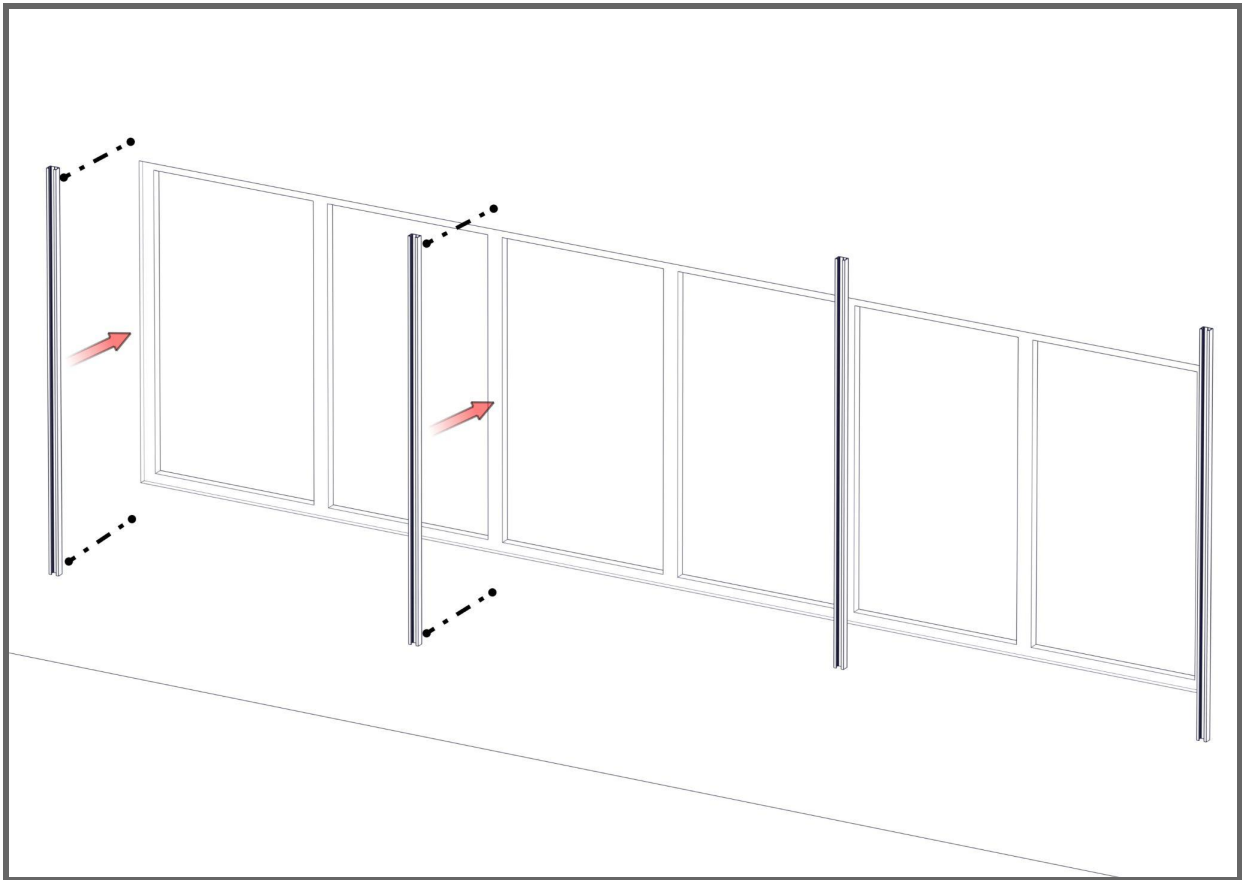

3.2.②.A. POST END CAPS

3.2.②.B. POST END CAP SCREWS

Install post end caps at the underside of posts (if applicable).

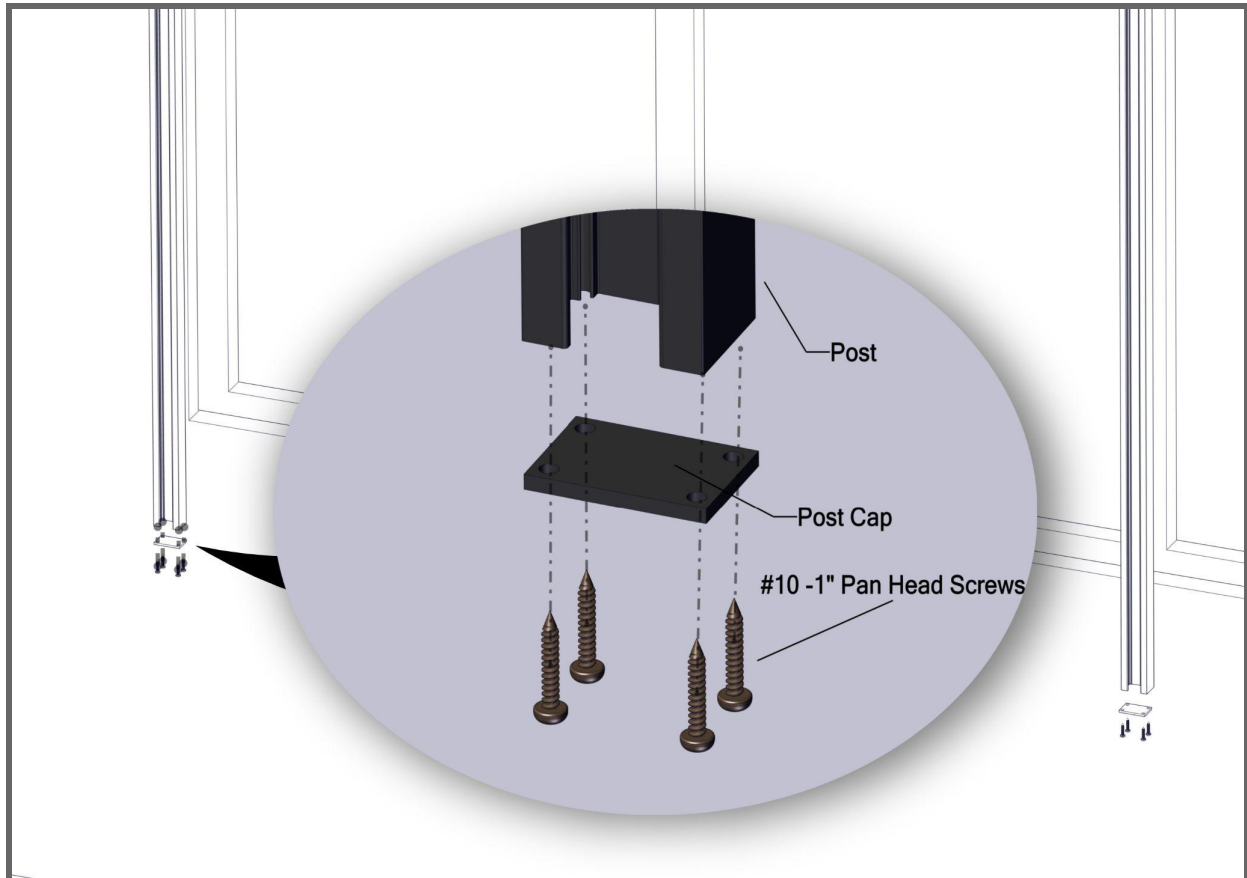

3.2.③. SPACER BAR

Install spacer bars (cutting where needed). Spacer bars are available in stock pre-cut lengths for 1" spacings and 12' full lengths to be cut on site for custom spacings. First and last bars may need cutting to a custom length to match field area spacing or for a flush finish from beam to post (1x5 only). 1x3 requires a minimum of $\frac{3}{4}$ " (19mm) protrusion of post beyond the outer beam edge.

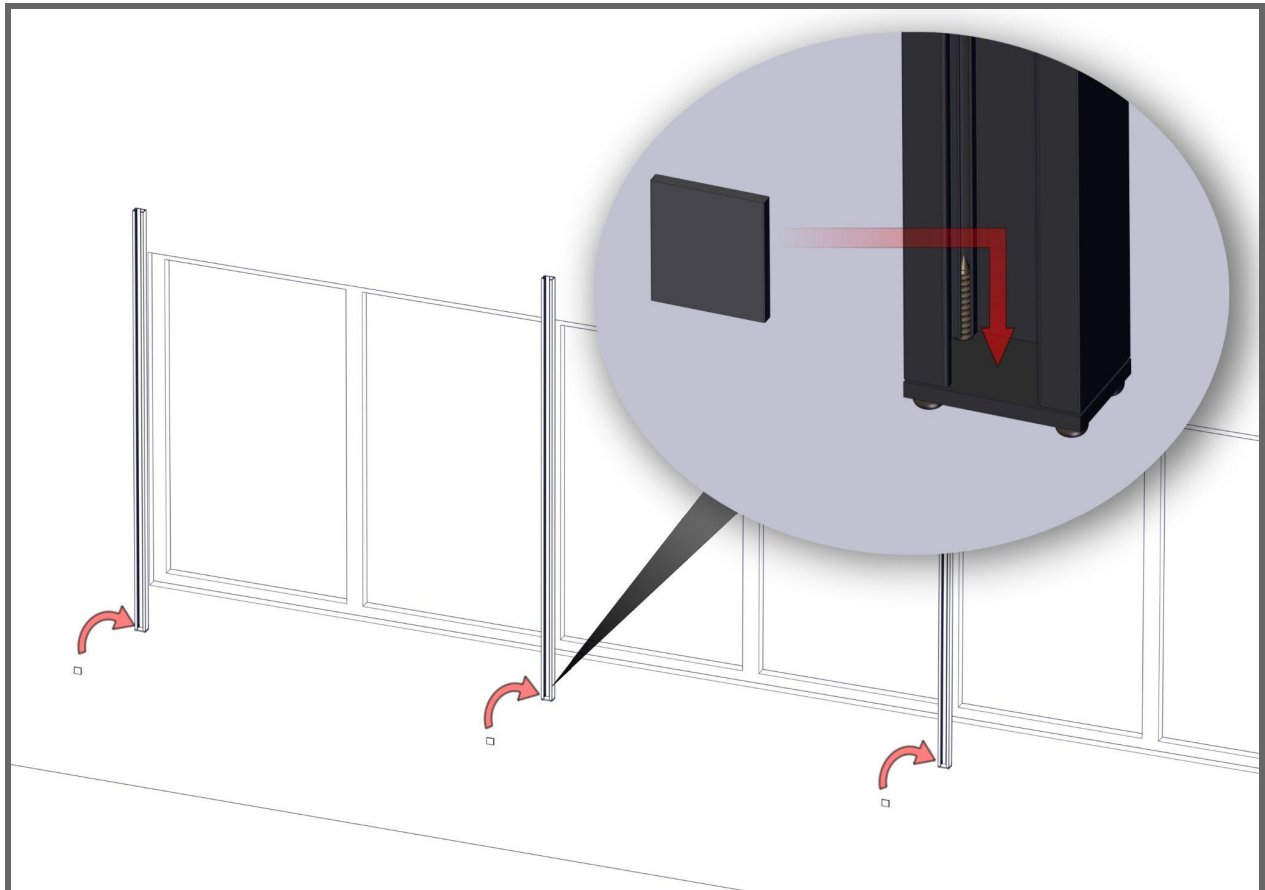

3.2.④. MOUNTING BRACKET

Install the Mounting Brackets to 1x3/1x5 beams (screws included) at each intersecting Single Post location.

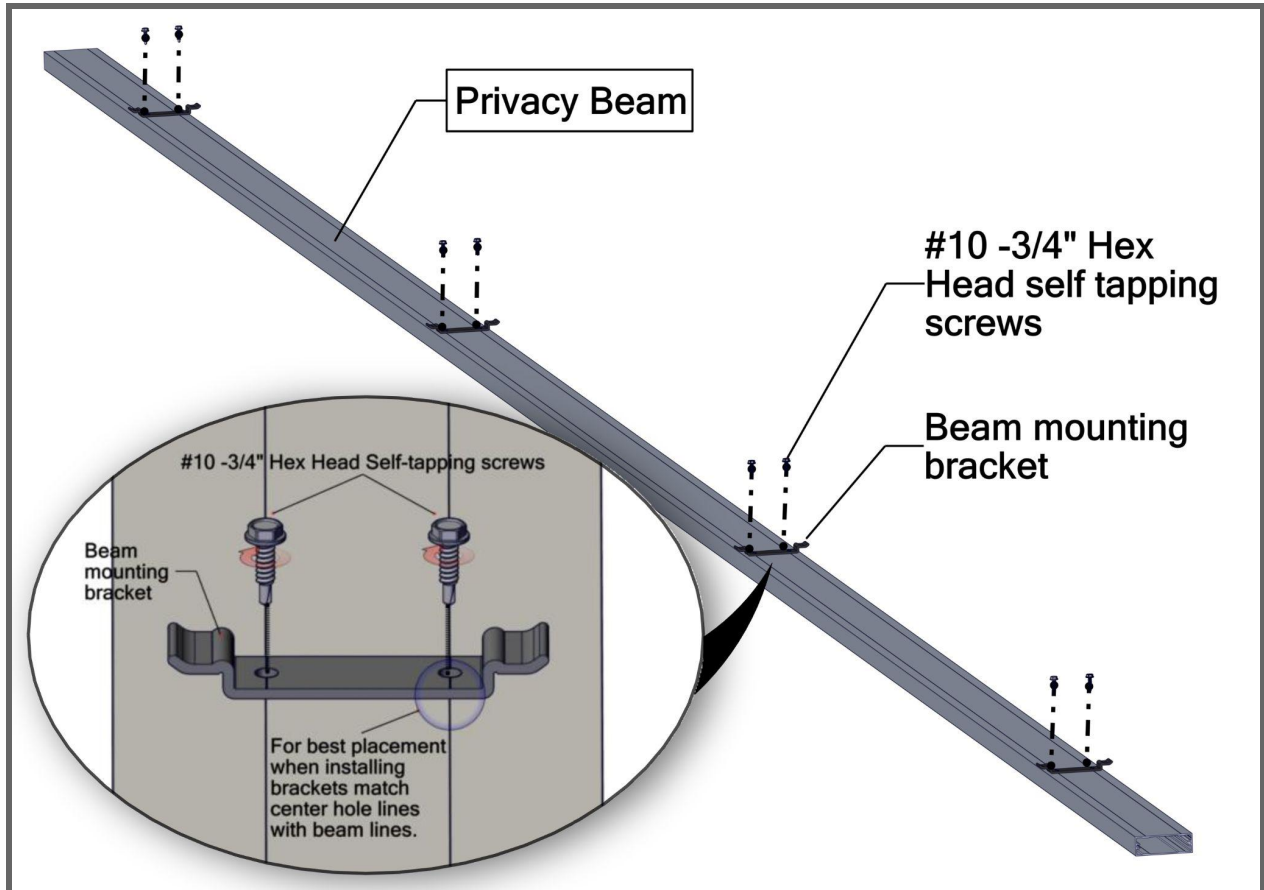

3.2.⑤. 1X3/1X5 BEAMS

Install 1x3/1x5 beams
Repeat steps ③, ④ & ⑤ until complete.

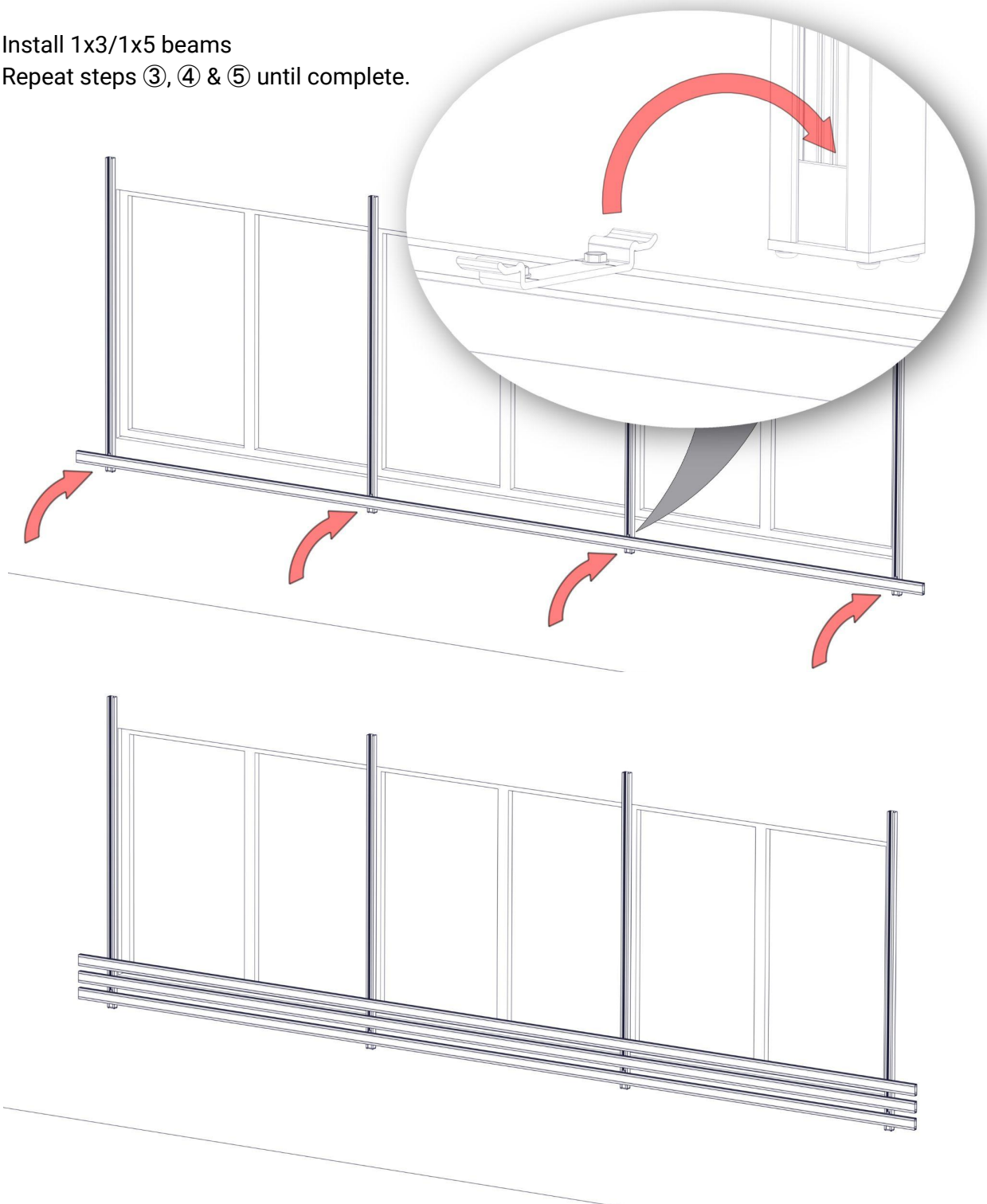

TIP! It is good practice to check your installation every 2-3 rows for alignment, for best results.

3.2.⑥. POST & BEAM END CAPS

Upon completion of the installed area(s), install any and all post and beam end caps at open ends.

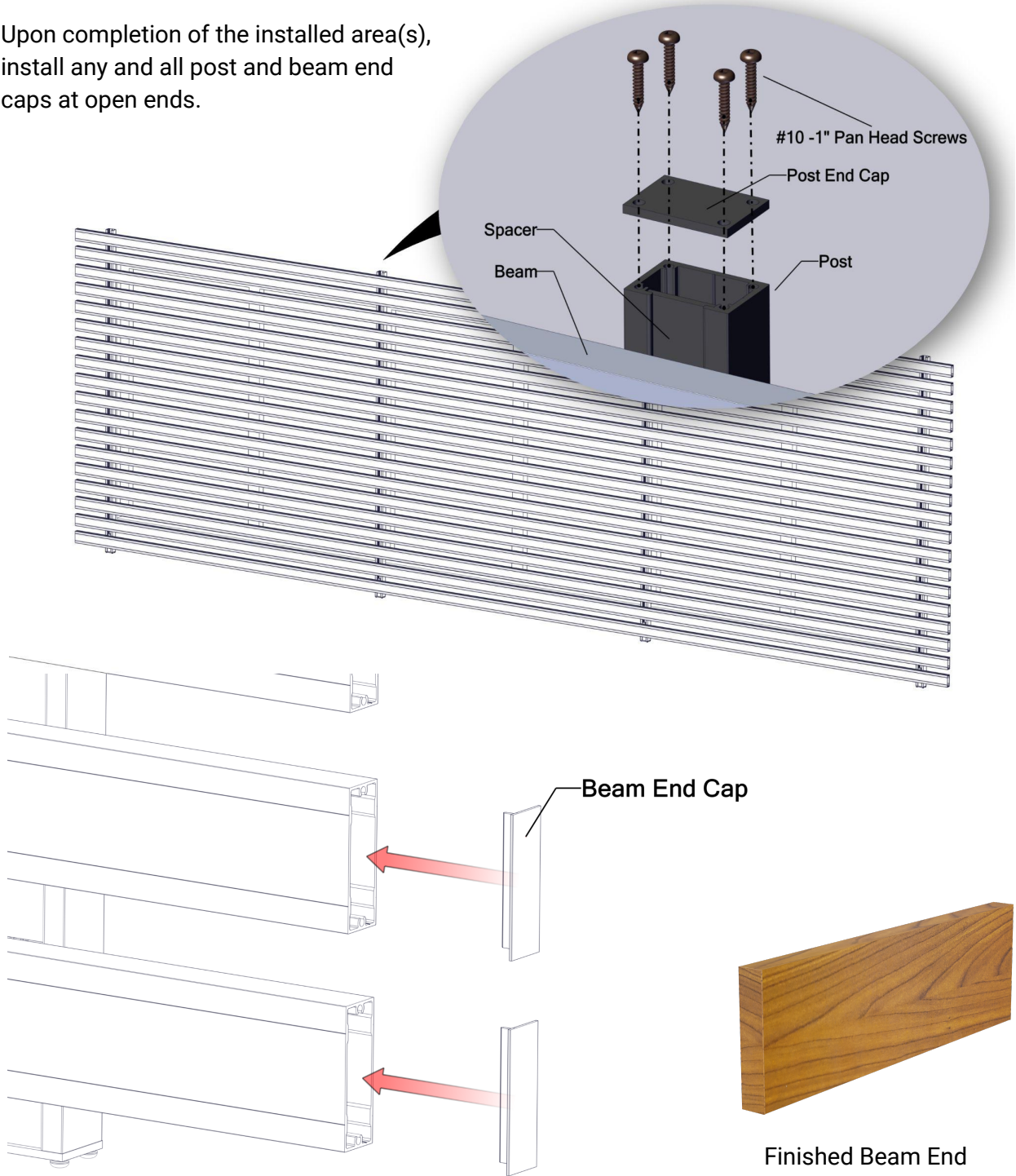

-----END FRAME SYSTEM-----

3.3.①. POSTS

Install single & double posts

When installing the posts as a freestanding element, set posts below grade using poured in place concrete following a 3:1 height ratio (see 1.4.). Posts should be placed at a maximum spacing of 6' (1.83m) o.c.

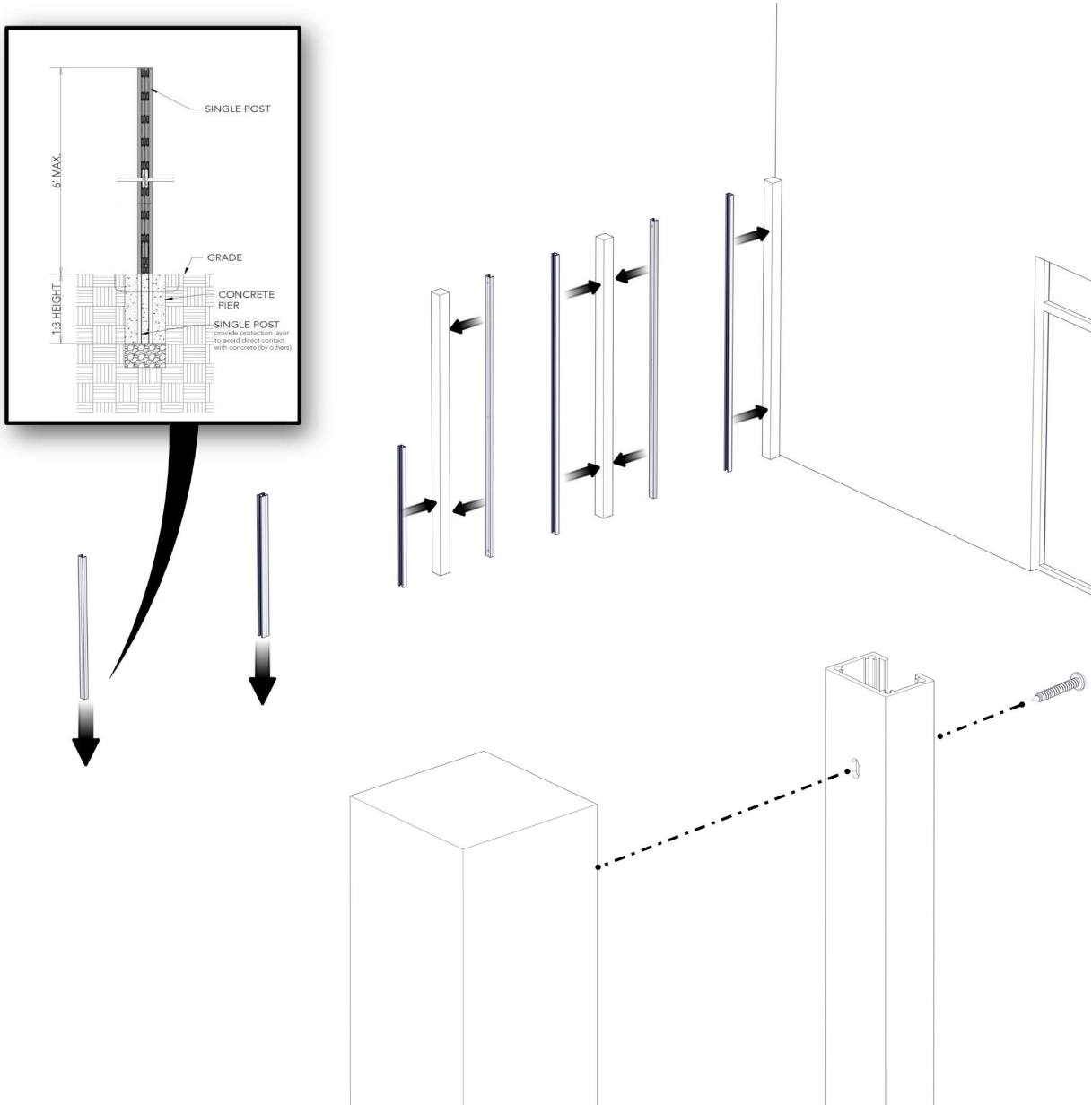

3.3.②. SPACER BLOCKS

Drop in spacer blocks from above.

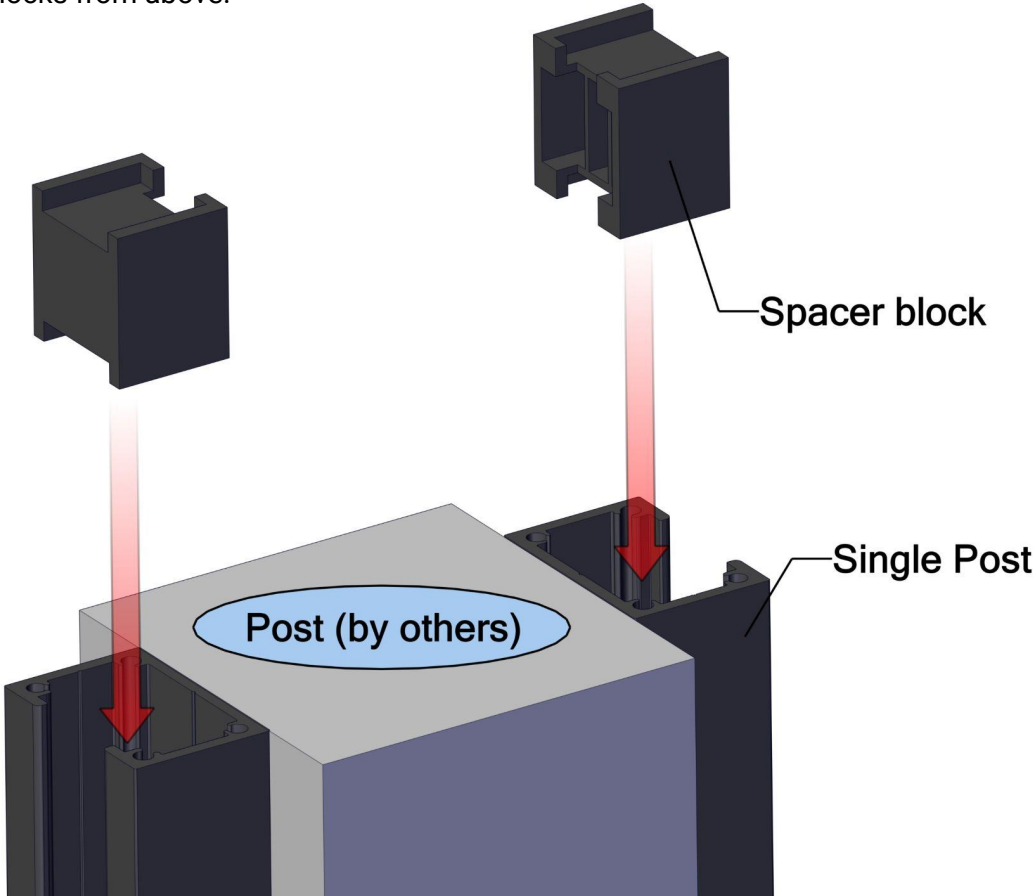

3.3.③. 1X3/1X5 BEAMS

Install Beams from above

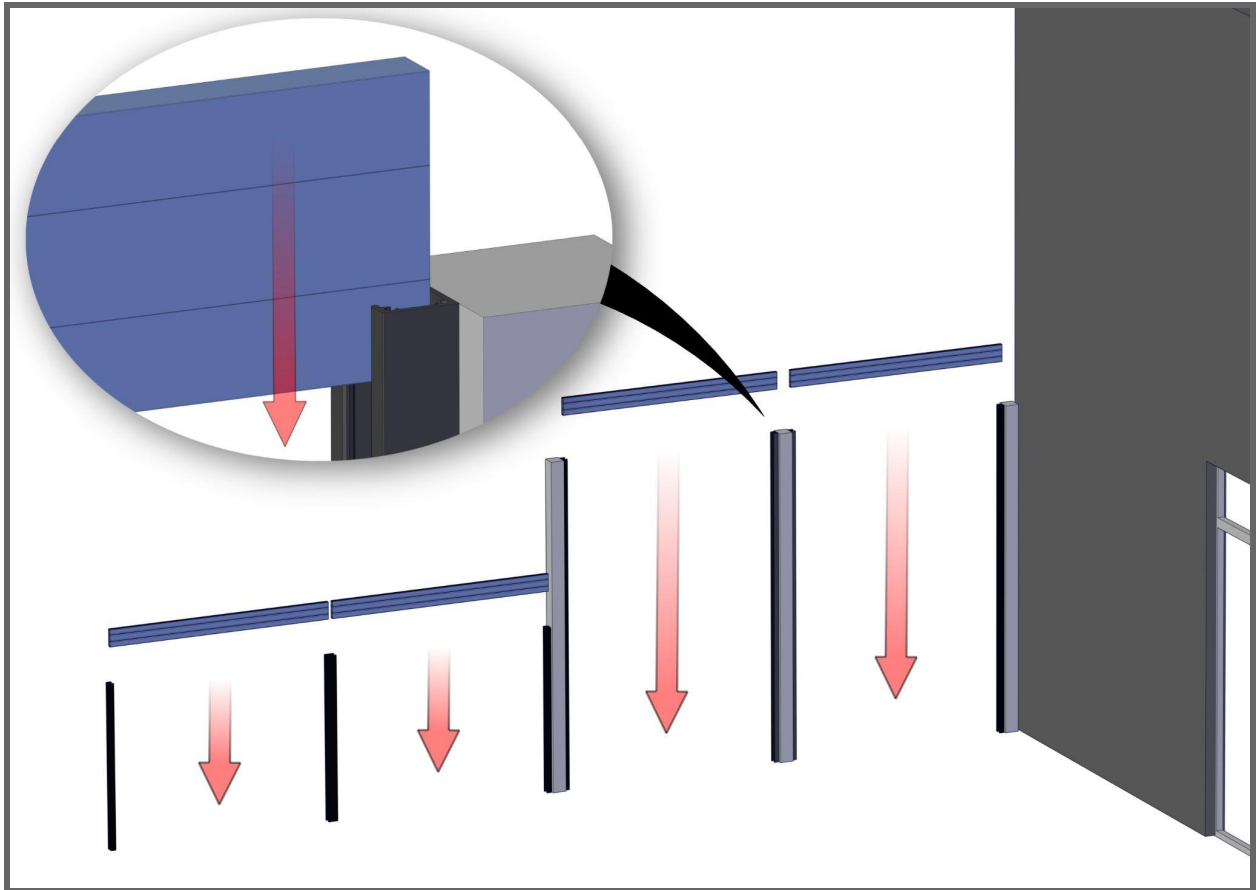

3.3.④. POST END CAPS

3.3.⑤. POST END CAP SCREWS

Install post end caps and screws

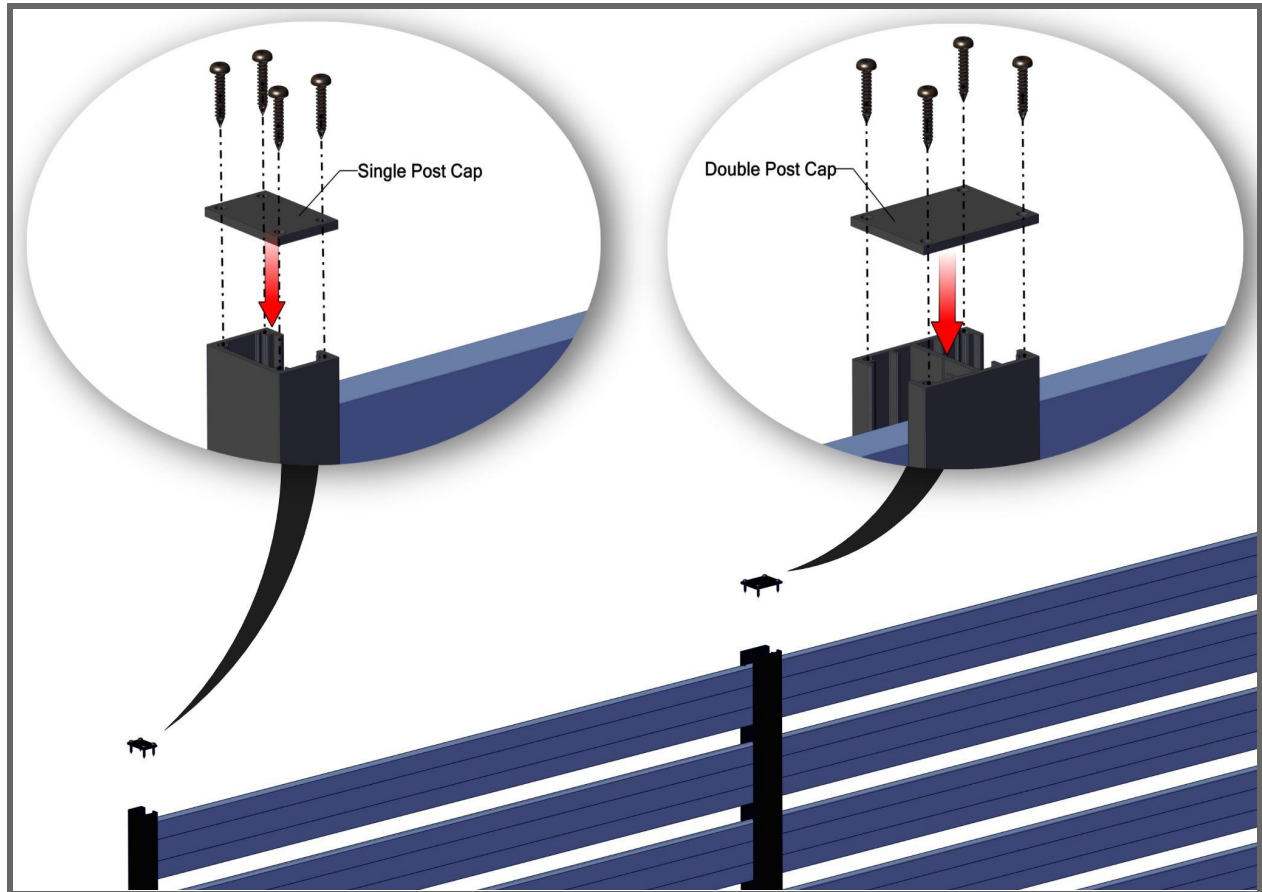

4.0. Cleaning Recommendations

**see Cleaning Guide for full requirements*

longboardproducts.com

While Longboard finishes require zero maintenance, we do recommend periodic cleaning to keep the product looking its best. Our finish is tested to withstand corrosion, fading and normal wear, however, neglect and rough conditions could have negative effects on the surface finish. These effects will not negate the structural performance of the product, but prolonged exposure to these conditions may result in permanent markings or surface damage.

Cleaning should be done in mild weather, and never in direct sunlight. Always complete a test patch on an inconspicuous area to ensure your detergent is suitable for the surface.

Your Longboard products should be cleaned immediately after installation. This is to remove any construction soils such as oils or dust. How to complete this initial cleaning depends on the level of dirt and the nature of the soil. See the cleaning guide for our suggestions based on soil level. Basic methods use a combination of moderate water pressure, soft sponge/brush and a mild detergent.

 NEVER use aggressive acid or alkaline cleaners on Longboard finishes. Do not use cleaners containing Trisodium Phosphate, Phosphoric Acid, Hydrochloric Acid, Hydrofluoric Acid, Fluorides or any other compound that is known to react with metal.

Always follow the product instructions for dilution. Cleaning the surface with a cleanser that is not diluted may result in damage to the coating.

5.0. WARRANTY









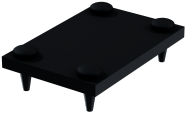

Upon substantial completion of the project, register for warranty online here:

longboardproducts.com/warranty

 Registration is required for the warranty to be in effect.













APPENDIX - FLOATING SYSTEM







INSTRUCTION STEP #	IMAGE	DESCRIPTION	SECTION DETAIL (scan or click)
①		1-½" X 2" SINGLE POST	
②A		1-½" X 2-½" SINGLE POST END CAP	
②B		POST END CAP SCREWS - #10 - 1" PAN-HEAD BLACK OXIDE	
③		1x3 SPACER BAR 1"	
③		1x5 SPACER BAR 1"	
③		1X3 & 1X5 SPACER BAR 12'	

INSTRUCTION STEP #	IMAGE	DESCRIPTION	SECTION DETAIL (scan or click)
④		<p>MOUNTING BRACKET w. 2 - #10 x 3/4" SS 410 5/16" HEX DRIVE SCREWS</p>	
⑤		<p>1X3 BEAM, 24' (7.3m) LENGTHS, WOODGRAIN, SOLID, SPECIALTY, CUSTOM SOLID</p>	
⑤		<p>1X5 BEAM, 24' (7.3m) LENGTHS, WOODGRAIN, SOLID, SPECIALTY, CUSTOM SOLID</p>	
⑥		<p>1X3 BEAM END CAP, WOODGRAIN, SOLID, SPECIALTY, CUSTOM SOLID</p>	
⑥		<p>1X5 BEAM END CAP, WOODGRAIN, SOLID, SPECIALTY, CUSTOM SOLID</p>	
		<p>PAINT PEN</p>	

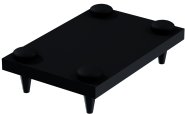

APPENDIX - END-FRAME SYSTEM

INSTRUCTION STEP #	IMAGE	DESCRIPTION	SECTION DETAIL (scan or click)
①		1-1/2" X 2" SINGLE POST	
①		2" X 3" DOUBLE POST	
②		1x3 & 1x5 SPACER BLOCK 1"	
③		1X3 BEAM, 24' (7.3m) LENGTHS, WOODGRAIN, SOLID, SPECIALTY, CUSTOM SOLID	
③		1X5 BEAM, 24' (7.3m) LENGTHS, WOODGRAIN, SOLID, SPECIALTY, CUSTOM SOLID	

INSTRUCTION STEP #	IMAGE	DESCRIPTION	SECTION DETAIL (scan or click)
④		1-½" X 2-⅛" SINGLE POST END CAP	
④		2-⅛" X 2-¾" DOUBLE POST END CAP	
⑤		POST END CAP SCREWS	
		PAINT PEN	