



Privacy Beam Screens & Enclosures

Installation Guidelines

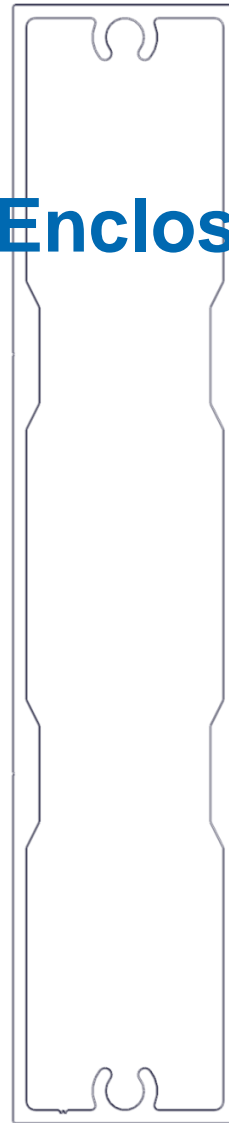
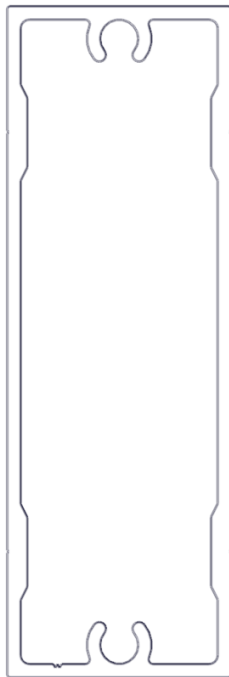

Table of Contents

Material Specifications	3
Finishes	3
Expansion and contraction	3
Material ordering and deliveries	3
Storage and handling	3
Cleaning	3
Warranty	3
Graffiti Cleaning	4
Components	5
Components (Typical)	5
Tools/Cutting/Fastening	6
Tools	6
Cutting	6
Fastening	7
Fastener types	7
Framing requirements	8
System Install	9
Perimeter and field area limitations	9
Component assembly overview	10
Floating system	10
End Frame system	11
Preparation drilling for install	12
Install steps	13
Floating system	13
End Frame system	14
Details	15
Butt-Joints	15
Appendix	16
Tables - Expansion & contraction	16
Tables – Design Pressure Tables	17
Handling and care of products	18
Blank Page	19
Contact Info	20

Material Specifications

Finishes

- Longboard Products are available in a wide range of powder coated finishes
- Custom solid colors are available upon request
- Longboard Products are not recommended for use on marine applications in direct contact with salt water

Longboard extruded products are produced 1" (25mm) oversized, as one end is drilled for the coating process, and both ends have 1/2" (12mm) of masking tape (woodgrains only) which must be cut off for best results. Longboard Cladding is to be installed outboard of a weather resistant barrier, including all flashings, following code, and building requirements.

Expansion & Contraction

Privacy Beam components expand & contract 1/4" (6mm) over 24' (7.3m) along the length, measured over a 30°C (54°F) temperature range. Due to this range of movement, Privacy Beam Fins /Battens should be installed with staggered butt-joints, leaving a 1/4" (6mm) min. gap, every 24' (7.3m) min.

See **Appendix for Tables 1 & 2, expansion/contraction calculations per foot/meter of material.**

Material Ordering & Delivery

- | | |
|--------------|---|
| • Packaging: | Privacy Beams are sold in 24' lengths, 1x3 & 1x5.
End caps are sold by the box: 20 caps/bx
Single Posts are sold in 24' lengths |
| • Shipping: | Most Popular Finishes -ready to ship within 1 week
Additional Finishes -ready to ship within 14 weeks
Delivered on 24' (7.3m) long skids weighing up to 2000 lbs. A mechanical lift with forks is required on site to receive the order. |
| • QC: | Always inspect the delivery for damage and contact LB ASAP if there are any issues: info@longboardproducts.com or 1-800-604-0343 and include your PO# and any pictures if possible. Mark the delivery receipt as "damaged" and accept the delivery as-is. Longboard is not responsible for the installation of blemished or damaged material. |

Storage & Handling

Be sure to store the material flat, keep it dry, safe & secure and remain in unopened cartons until ready to be installed. See **Appendix for proper handling and care instructions.**

Cleaning Recommendations

- Initial and periodic cleaning for best looking product
- Basic methods use a combination of moderate water pressure, soft sponge/brush and a mild detergent (Safe for your hands, safe for the product)

⚠ NEVER use aggressive acid or alkaline cleaners on Longboard finishes. Do not use cleaners containing Trisodium Phosphate, Phosphoric Acid, Hydrochloric Acid, Hydrofluoric Acid, Fluorides, or any other compound that is known to react with metal.

See *Cleaning Guide for full requirements & cleaning schedule:
longboardproducts.com/resources/care-maintenance.com

Warranty

Upon substantial completion of the project, register for warranty online here: longboardproducts.com/warranty

⚠ Registration is required for the warranty to be in effect.

Graffiti Removal

Standard Woodgrain

Use Standard soap & water only

D2000 Solid Color

	Prosoco Cleaner	MEK Solvent
Permanent Marker	<input checked="" type="checkbox"/>	<input checked="" type="checkbox"/>
Oil Based Spray Paint	<input checked="" type="checkbox"/>	<input checked="" type="checkbox"/>
Water Based Spray Paint	<input checked="" type="checkbox"/>	<input checked="" type="checkbox"/>
Adhesive Tape	<input checked="" type="checkbox"/>	<input checked="" type="checkbox"/>

MEK Solvent

Prosoco Anti-Graffiti Cleaner

SPECIAL ORDER - EXT. LEAD TIMES CONTACT LB

Anti-Graffiti High Gloss Woodgrain

	MEK Solvent
Permanent Marker	<input checked="" type="checkbox"/>
Oil Based Spray Paint	<input checked="" type="checkbox"/>
Water Based Spray Paint	<input checked="" type="checkbox"/>
Adhesive Tape	<input checked="" type="checkbox"/>









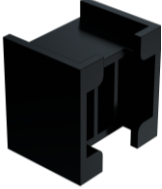

MEK Solvent

Note: Cleaning the surface with a cleanser that is not diluted as per instructions, may result in damage to the coating.

Components

Components (Typical)







The Privacy Beam system consists of Beams attached to Single Posts and installed onto a support structure. For all LB components go to longboardproducts.com.

 <p>1x3 Beam (1" width) 1X3B.289</p>	 <p>1x5 Beam (1" width) 1X5B.289</p>	 <p>Beam End Caps (1" width) 1BEC.3, 1BEC.5</p>	 <p>Spacer Block (For 1x3 & 1x5) 2X2SB</p>
 <p>Single Post (1 1/2"x2") 2X2SP.289</p>	 <p>Single Post End Cap 2X2PC.2</p>	 <p>Post End Cap Screws #10-1 Pan Head (square drive) PECS</p>	 <p>Spacer Bar (1" width) 12' length - 1X2FB.145 1" length- 1X2FB.1 (100/Box) 3" length- 1X2FB.3 (100/Box)</p>
 <p>Mounting Bracket (100/Box) 3PSMB</p>	 <p>Mounting Bracket Screws #10-16x3/4 Tek Hex Head (200/Box) *Included x 2 with bracket</p>	 <p>Paint Pen TUP</p>	

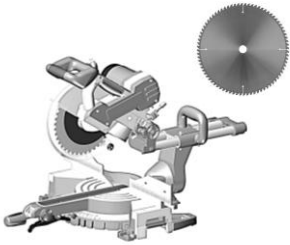
Tools/Cutting/Fastening

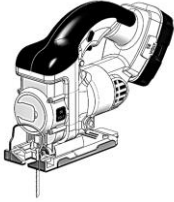
Tools

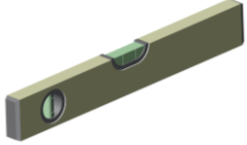
Commonly used tools for Privacy Beam install.

			
Table Saw with Carbide Metal Blade Non-ferrous 60-80T (for cutting aluminum)	Miter Saw with Carbide Metal Blade Non-ferrous 60-80T (for cutting aluminum)	Cordless Drill with clutch	Jig Saw (for protrusions)
			
Rubber Mallet (or Hammer)	Level	#2 Square Drive Bit (Roberston)	3/8" Hex Head Driver

Cutting

⚠ Always be sure to wear appropriate PPE: eye & hearing protection.

Cut battens using a Miter Saw and Table Saw always allowing for expansion & contraction. Trim the taped/drilled ends of all stock length material by at least **1/2" (12mm) each end** and discard.

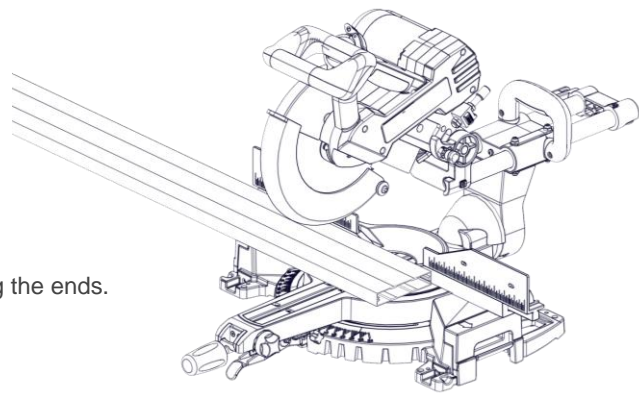

⚠ **DO NOT** Install Privacy Beams without trimming the ends.

Fastening

Longboard Privacy Beam consists of 1x3 & 1x5 extrusions which are installed onto single posts using mounting brackets for Floating system or spacer blocks for End Frame system. These posts are fastened with #12 fasteners (by others) to a solid secure support structure or substrate, sharp-point screws (for wood substrates) or self-drilling (for metal substrates).

Fasteners must be corrosion resistant and comply with all local building codes.

⚠ All fasteners should be suitable for exterior use and be compatible with the substrate type. **Fasteners should be anchored into a solid secure substrate.**

⚠ See Appendix for project specific fastener spacing: Tables 3 & 4

Fastener types

RECOMMENDED

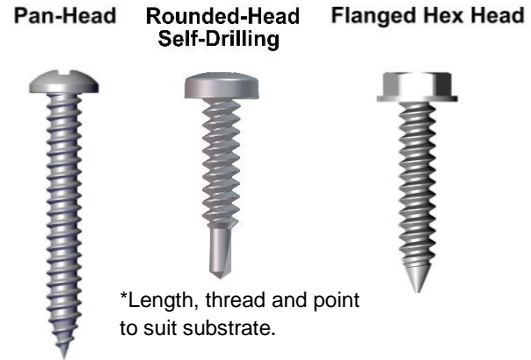

FLOATING SYSTEM			
SUBSTRATE	ANCHOR DESCRIPTION	MIN. EMBEDMENT	MIN. EDGE DISTANCE
WOOD MIN. S.G. =0.55	#12 WOOD SCREW	1-1/2"	1"
STEEL: MIN. 1/16" THICK, MIN. Fy =36 KSI	#12 SELF-DRILLING OR SELF-TAPPING SCREW (GRADE 5)	3 THREADS PENETRATION PAST METAL STRUCTURE	1/2"
ALUM.: MIN. 1/8", MIN. 6063-T5			
CONCRETE MIN. F'C =3000 PSI	3/16" ITW TAPCON	1-1/2"	1-7/8"
HOLLOW / GROUT-FILLED BLOCK PER C-90 MIN. F'C =2000 PSI	3/16" DEWALT ULTRACON+	1-1/4"	2"

Floating System

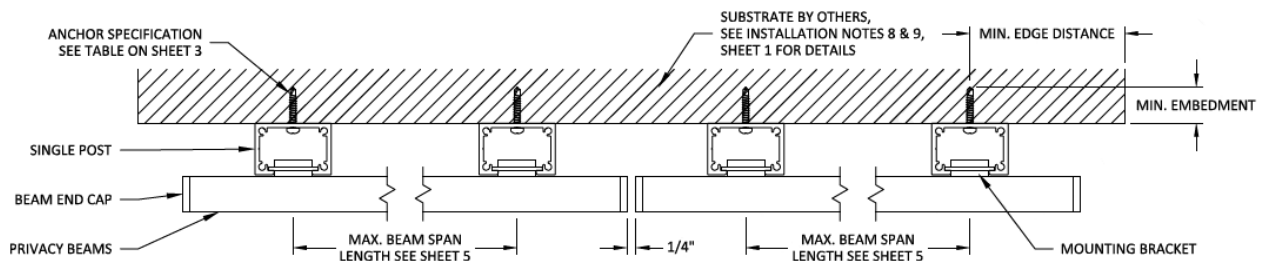

END FRAME SYSTEM			
SUBSTRATE	ANCHOR DESCRIPTION	MIN. EMBEDMENT	MIN. EDGE DISTANCE
WOOD MIN. S.G. =0.55	#12 WOOD SCREW	1-1/2"	1"
STEEL: MIN. 18 GA., MIN. Fy =36 KSI	#12 SELF-DRILLING OR SELF-TAPPING SCREW (GRADE 5)	3 THREADS PENETRATION PAST METAL STRUCTURE	1/2"
ALUM.: MIN. 1/8", MIN. 6063-T5			
CONCRETE MIN. F'C =3000 PSI	3/16" ITW TAPCON	1-1/2"	2"
HOLLOW / GROUT-FILLED BLOCK PER C-90 MIN. F'C =2000 PSI		1"	3"

End Frame System

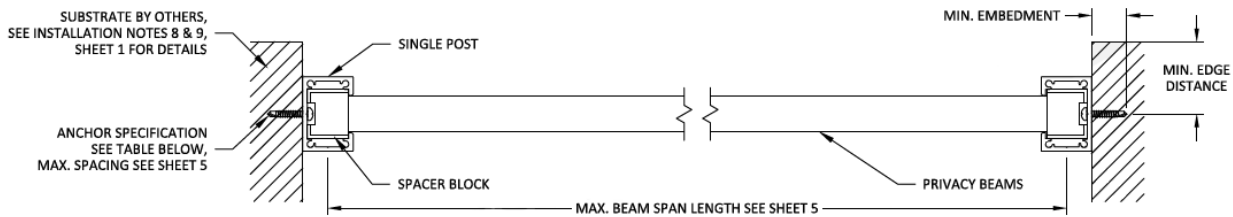

Framing requirements

Always consult your local building authority and follow local building code requirements. See Typical dimensions for sizes and weights of the Privacy Beam system.

Wood Framing

- Size: 2x4 minimum
- Spacing: 16" (406mm) O.C.

Metal Framing

- Gauge: 18 ga. minimum
- Spacing: 16" (406mm) O.C.

Concrete/CMU

When application calls for wood or metal furring over concrete and CMU use:

Wood Furring:

- Size: 2x2 minimum
- Type: Pressure treated lumber
- Spacing: 16" (406mm) O.C.

Metal Furring:

- Size: 18 ga. minimum
- Type: Hat channel, c-stud, or z-furring.
- Spacing: 16" (406mm) O.C.

System Install

Perimeter and field area limitations

Measure and layout your application area to consider Privacy Beam alignment with fixtures, penetrations, and adjacent walls, for desired appearance. The same methodology applies for vertical installations.

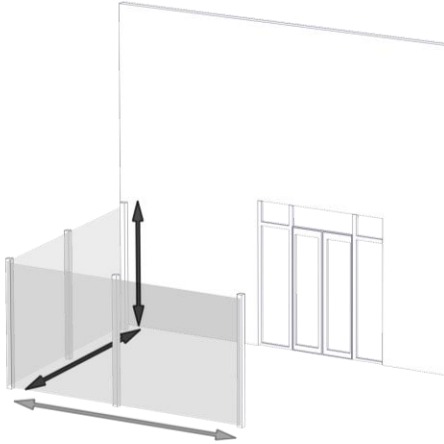

End Frame System

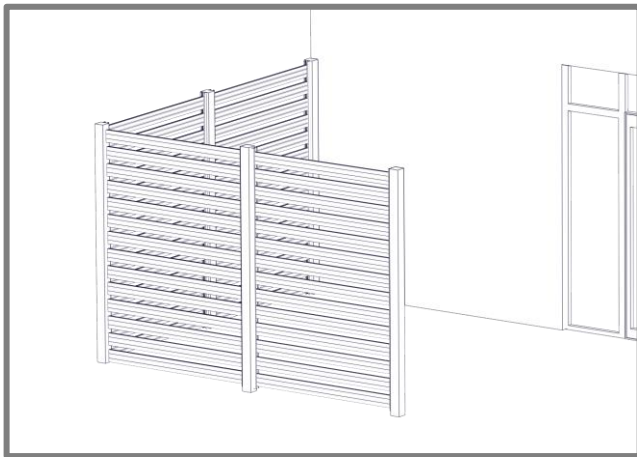
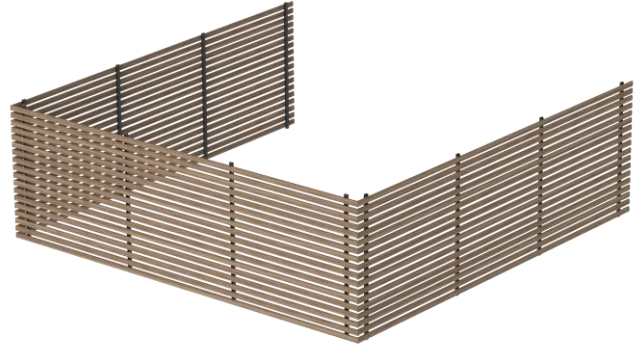

Component assembly overview

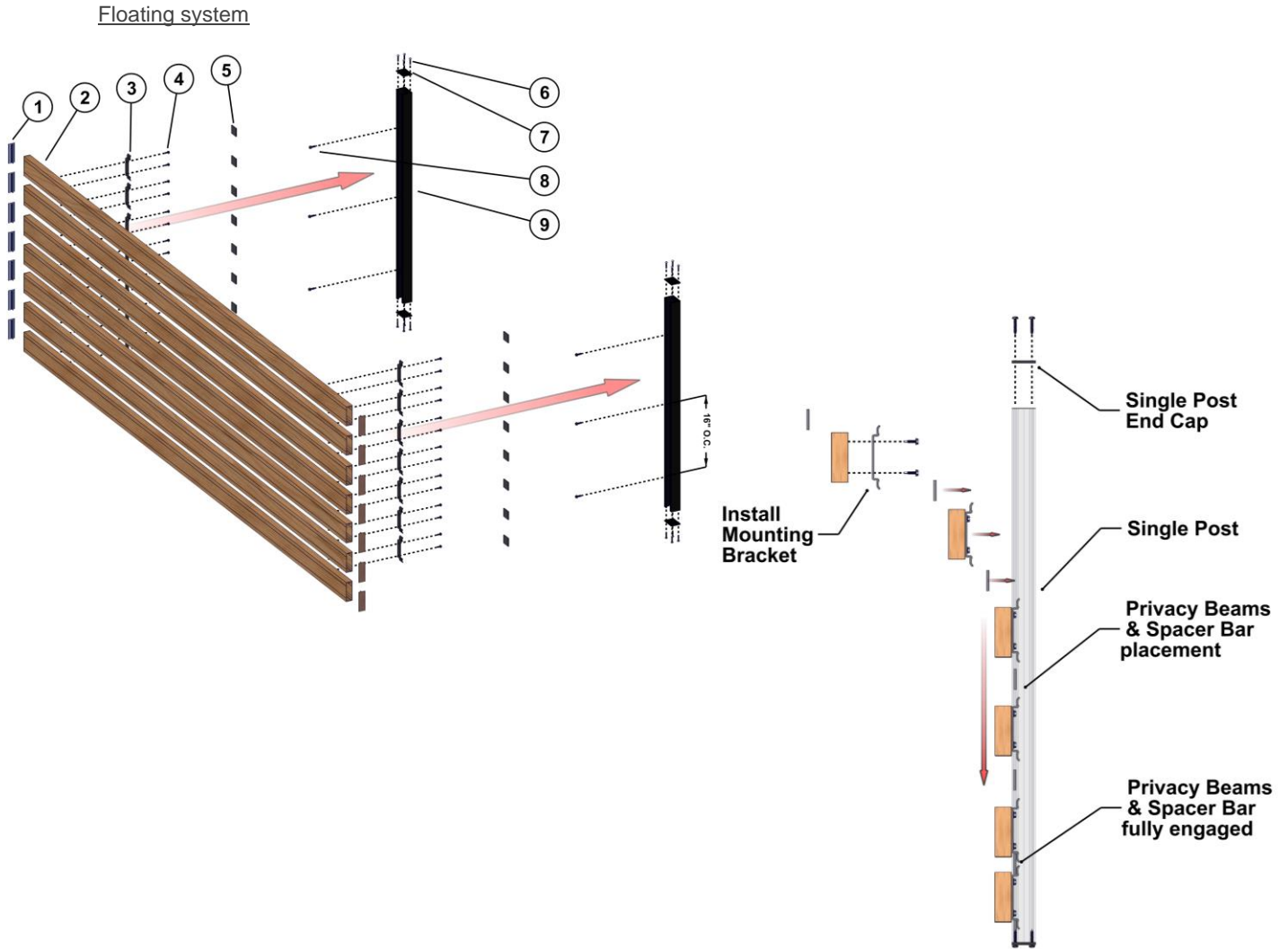

No.	Description	Details	SKU
1	End Cap	-End Caps are friction fit onto ends of the Privacy Beams	1BEC.3, 1BEC.5
2	Privacy Beam	-1"x3" Beam, 1"x5" Beam	1X3B.289, 1x5B.289
3	Mounting Bracket	-Secured onto Beam, (100/box)	3PSMB
4	#10-16x3/4 Tek Hex Head Screw	-For securing the bracket to the Beam Included x 2 with bracket, (200/box)	Included with Mounting Bracket
5	Spacer bar (1" piece)	-For spacing between the Beams 12' length, 1" length- (100/Box), 3" length- (100/Box)	1X2FB.145, 1X2FB.1, 1X2FB.3
6	#10-1 Pan Head Screw	-For securing the Single Post End caps (sold separately)	PECS
7	Single Post End Cap	-Secured onto the end of the Single Posts	2X2PC.2
8	#12 Fastener (by others)	-Used to secure the Posts to the structure. For spacings subject to loading see tables 3 & 4 in appendix.	N/A
9	Single Post	-Installed at 6' O.C. typical spacing, Beams are connected to the posts via the mounting bracket	2X2SP.289

End Frame system

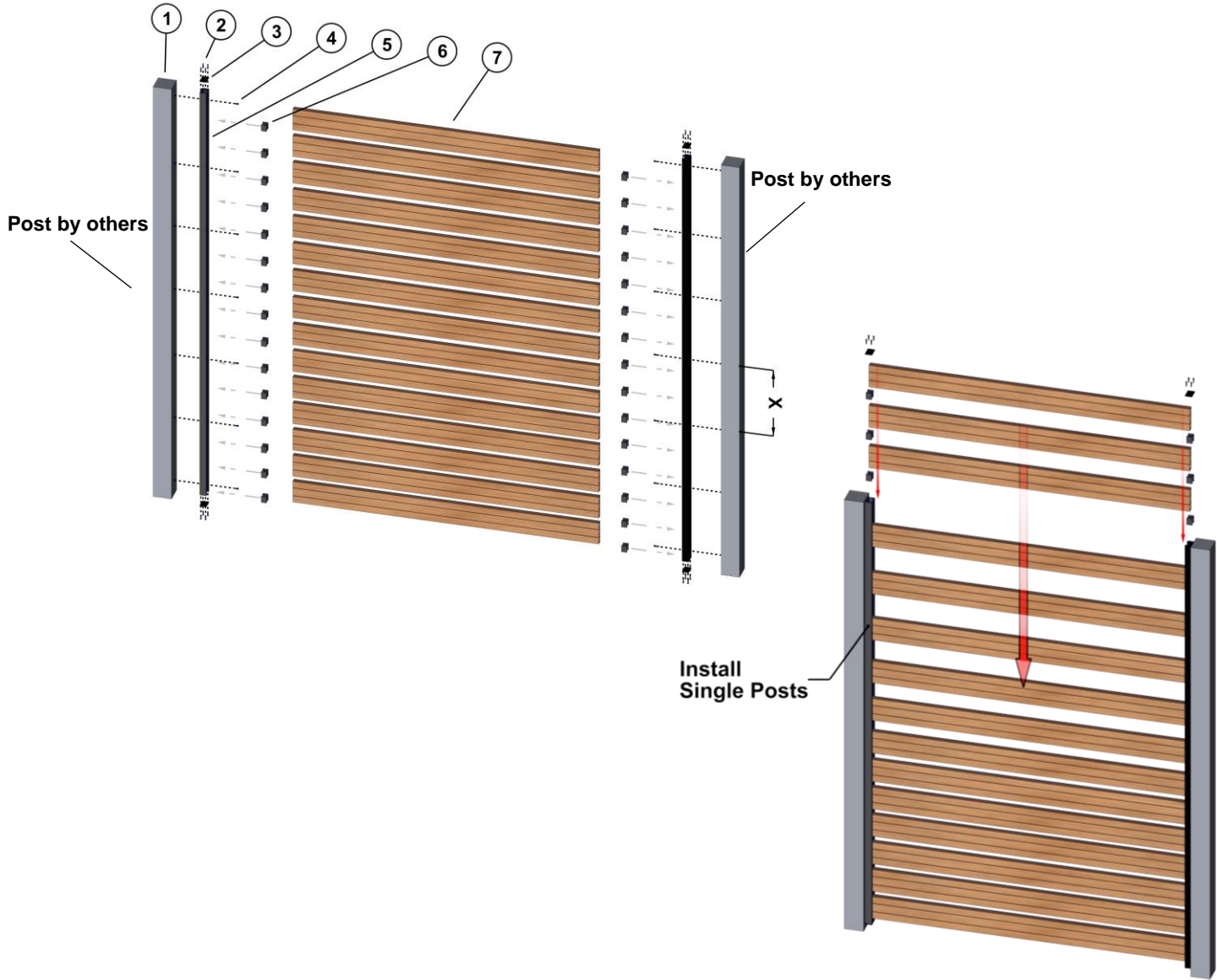

No.	Description	Details	SKU
1	Post or structural member	-By others	N/A
2	#10-1 Pan Head Screw	-For securing the Single Post End caps (sold separately)	PECS
3	Single Post End Cap	-Secured onto the end of the Single Posts	2X2PC.2
4	#12 Fastener (by others)	-Used to secure the Posts to the structure. For spacings subject to loading see tables 3 & 4 in appendix.	N/A
5	Single Post	-Installed at 6' O.C. typical spacing, Beams are connected to the posts via the mounting bracket	2X2SP.289
6	Spacer Block	-For spacing between the Beams (1" spacing)	2X2SB
7	Privacy Beam	-1"x3" Beam, 1"x5" Beam	1X3B.289, 1x5B.289

Preparation drilling for Install

To prepare the Privacy Beam system for install, predrill the single posts with 1/2" holes every 16" O.C. typical with the first hole approx. 2" in from the end.

*For fastener max. spacing (X), see tables 3 & 4 in Appendix for project specific design pressure.

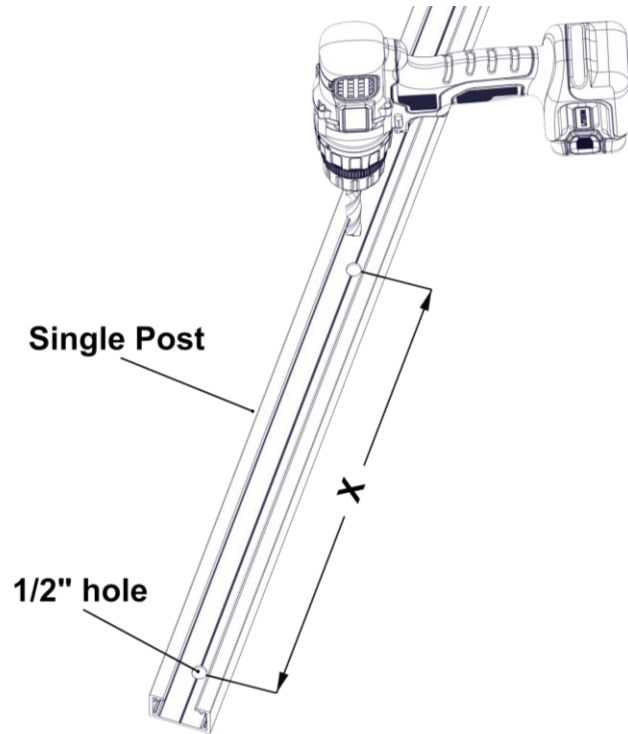

Anchoring for End Frame System

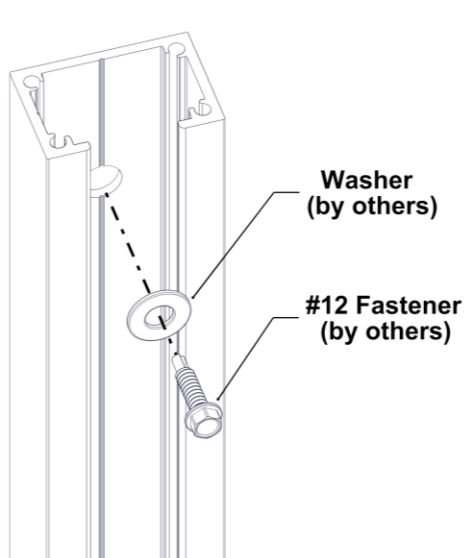

Anchoring for Floating System

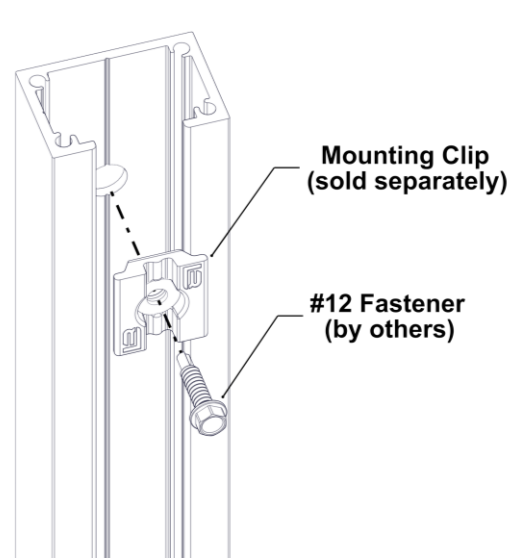

Install steps

Floating system

Step 1

Layout and install predrilled Privacy Posts onto secure structure. It is good practice to check your installation every 2-3 rows for level/plumb and flat/straight, for best result.

Note: Be sure to fasten in the center of the 1/2" holes to allow for movement each way. Hard fasten near the center of each length to prevent migration of the material over time.



Step 2

Install bottom Single Post End Cap and Spacer Bar.

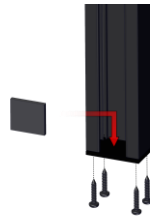

Step 3

Fasten Mounting Brackets onto Privacy Beams at desired spacing for the connection to the Single Posts. Use the Die lines as guides for the Mounting Bracket positioning.



Step 4

Install Privacy Beams onto the Single Posts locking into place and continue until all are in place.

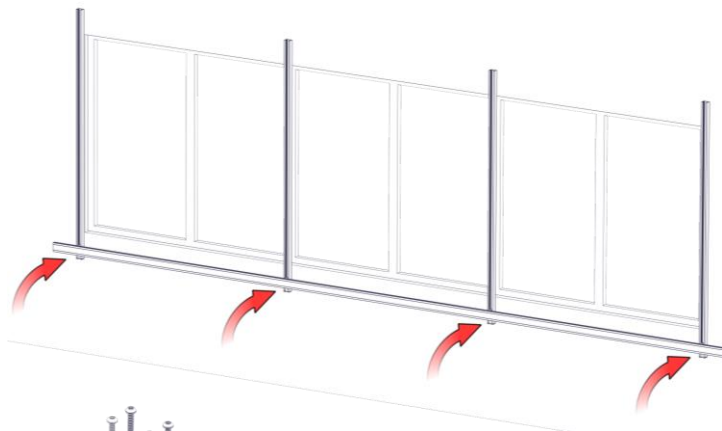

Step 5

To finish, install the last Spacer Bar and Single Post End Cap. Then install Privacy Beam End Caps.

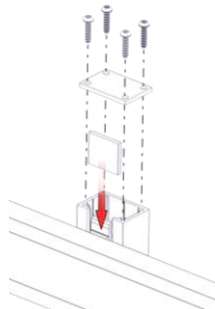

Install steps

End Frame system

Step 1

Install bottom Single Post End Cap.

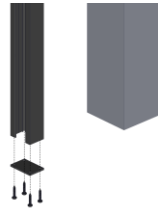

Step 2

Install predrilled Privacy Posts onto secure structure. It is good practice to check your installation every 2-3 rows for level/plumb and flat/straight, for best result.

Note: Be sure to fasten in the center of the 1/2" holes to allow for movement each way. Hard fasten near the center of each length to prevent migration of the material over time.

***For fastener max. spacing (X), see tables 3 & 4 in Appendix for project specific loading.**

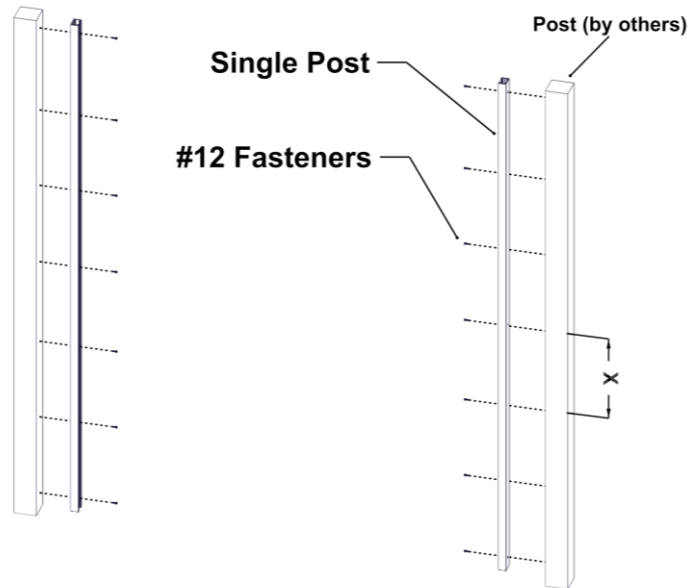

Step 3

Place Spacer Block into Post from top of Post and slide down to required location.

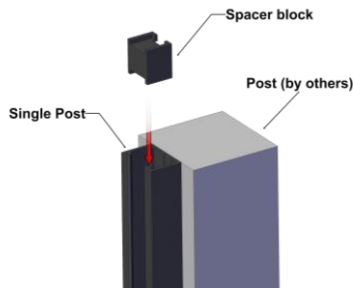

Step 4

Cut and place Privacy Beam into Single Posts. Then another Spacer Block and Beam and repeat.

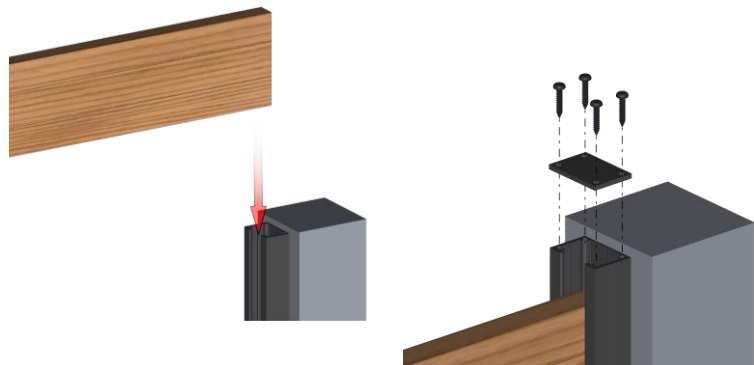

Step 5

To finish, install the Single Post End Cap.

Details

Butt-Joints

-  **BUTT-JOINTS.** When installing butt-joints, ensure to leave a 1/4" (6mm) min. gap. every 24' (7.3m) min. (See Detail A).

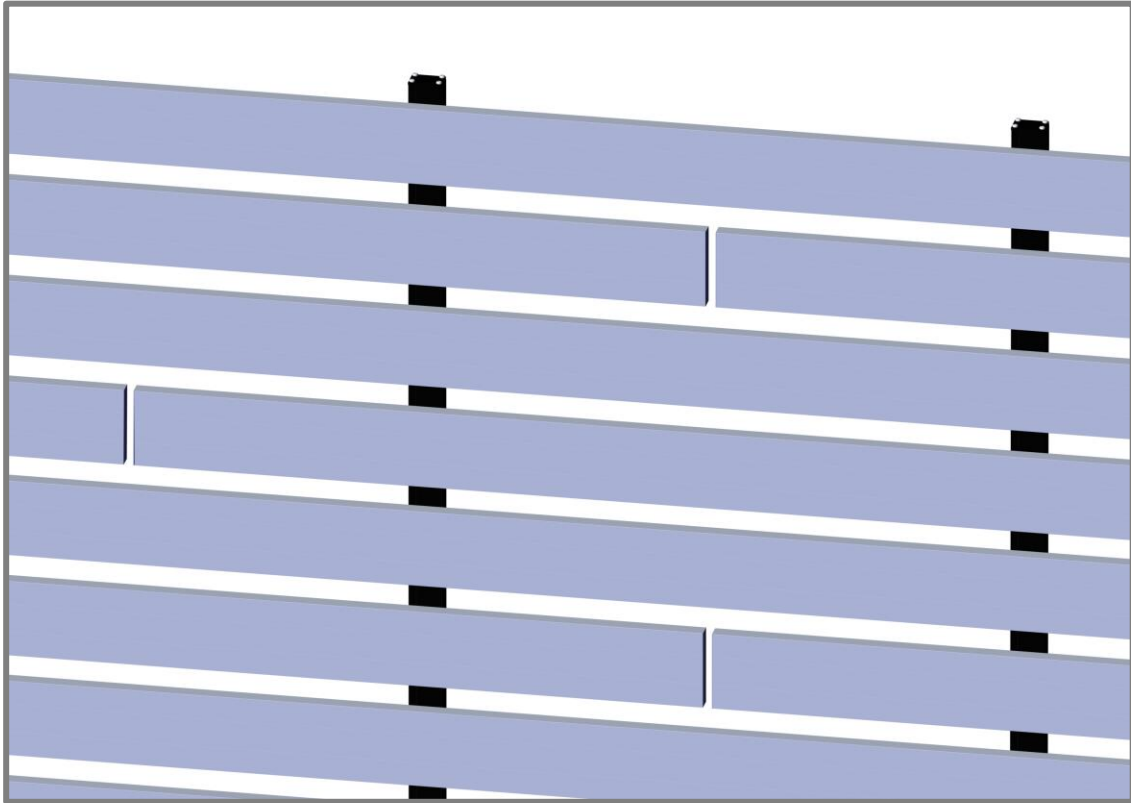

Detail A

Appendix

Expansion and Contraction Tables

TABLE 1 - IMPERIAL

		AVERAGE TEMPERATURE AT TIME OF CUTTING & INSTALLATION											
°C		-50	-40	-30	-20	-10	0	10	20	30	40	50	
°F		-58	-40	-22	-4	14	32	50	68	86	104	122	
MIN/MAX POST CONSTRUCTION TEMP.	°C	°F	EXPANSION OR CONTRACTION (INCH/FOOT)										
	-50	-58	0.000	-0.003	-0.005	-0.008	-0.011	-0.014	-0.016	-0.019	-0.022	-0.024	-0.027
	-40	-40	0.003	0.000	-0.003	-0.005	-0.008	-0.011	-0.014	-0.016	-0.019	-0.022	-0.024
	-30	-22	0.005	0.003	0.000	-0.003	-0.005	-0.008	-0.011	-0.014	-0.016	-0.019	-0.022
	-20	-4	0.008	0.005	0.003	0.000	-0.003	-0.005	-0.008	-0.011	-0.014	-0.016	-0.019
	-10	14	0.011	0.008	0.005	0.003	0.000	-0.003	-0.005	-0.008	-0.011	-0.014	-0.016
	0	32	0.014	0.011	0.008	0.005	0.003	0.000	-0.003	-0.005	-0.008	-0.011	-0.014
	10	50	0.016	0.014	0.011	0.008	0.005	0.003	0.000	-0.003	-0.005	-0.008	-0.011
	20	68	0.019	0.016	0.014	0.011	0.008	0.005	0.003	0.000	-0.003	-0.005	-0.008
	30	86	0.022	0.019	0.016	0.014	0.011	0.008	0.005	0.003	0.000	-0.003	-0.005
	40	104	0.024	0.022	0.019	0.016	0.014	0.011	0.008	0.005	0.003	0.000	-0.003
	50	122	0.027	0.024	0.022	0.019	0.016	0.014	0.011	0.008	0.005	0.003	0.000

TABLE 2 - METRIC

		AVERAGE TEMPERATURE AT TIME OF CUTTING & INSTALLATION											
°C		-50	-40	-30	-20	-10	0	10	20	30	40	50	
°F		-58	-40	-22	-4	14	32	50	68	86	104	122	
MIN/MAX POST CONSTRUCTION TEMP.	°C	°F	EXPANSION OR CONTRACTION (MM/METER)										
	-50	-58	0.000	-0.230	-0.460	-0.690	-0.920	-1.150	-1.380	-1.610	-1.840	-2.070	-2.300
	-40	-40	0.230	0.000	-0.230	-0.460	-0.690	-0.920	-1.150	-1.380	-1.610	-1.840	-2.070
	-30	-22	0.460	0.230	0.000	-0.230	-0.460	-0.690	-0.920	-1.150	-1.380	-1.610	-1.840
	-20	-4	0.690	0.460	0.230	0.000	-0.230	-0.460	-0.690	-0.920	-1.150	-1.380	-1.610
	-10	14	0.920	0.690	0.460	0.230	0.000	-0.230	-0.460	-0.690	-0.920	-1.150	-1.380
	0	32	1.150	0.920	0.690	0.460	0.230	0.000	-0.230	-0.460	-0.690	-0.920	-1.150
	10	50	1.380	1.150	0.920	0.690	0.460	0.230	0.000	-0.230	-0.460	-0.690	-0.920
	20	68	1.610	1.380	1.150	0.920	0.690	0.460	0.230	0.000	-0.230	-0.460	-0.690
	30	86	1.840	1.610	1.380	1.150	0.920	0.690	0.460	0.230	0.000	-0.230	-0.460
	40	104	2.070	1.840	1.610	1.380	1.150	0.920	0.690	0.460	0.230	0.000	-0.230
	50	122	2.300	2.070	1.840	1.610	1.380	1.150	0.920	0.690	0.460	0.230	0.000

Ultimate Pressure Tables

TABLE 3

1X3 BEAM		MAX ANCHOR SPACING FOR POSTS (IN)					
		FLOATING SYSTEM			END FRAME SYSTEM		
ALLOWABLE SPAN (FT)	ULTIMATE PRESSURE (PSF)	WOOD	STEEL / ALUM.	CONCRETE / MASONRY	WOOD	STEEL / ALUM.	CONCRETE / MASONRY
4	72	15.5	6	6	6	12	6
6	42						
7	24	24	12	12	12	24	12
8	18						

TABLE 4

1X5 BEAM		MAX ANCHOR SPACING FOR POSTS (IN)					
		FLOATING SYSTEM			END FRAME SYSTEM		
ALLOWABLE SPAN (FT)	ULTIMATE PRESSURE (PSF)	WOOD	STEEL / ALUM.	CONCRETE / MASONRY	WOOD	STEEL / ALUM.	CONCRETE / MASONRY
4	72	15.5	6	6	6	14	6
6	36	21	8	8	8	20	8
7	18	24	14	14	14	24	12

Proper Handling of Longboard Products



To help avoid injury and product damage, Longboard products require proper handling to and from storage areas during installation. When carrying or installing any products it is recommended that they be moved or carried by at least two people with each support point approximately 4ft from the ends. **Carrying products without proper support can cause excessive bending which may damage the appearance or finish of the product.** Any short cut lengths should also be carried on edge while supporting the material. See below for details.

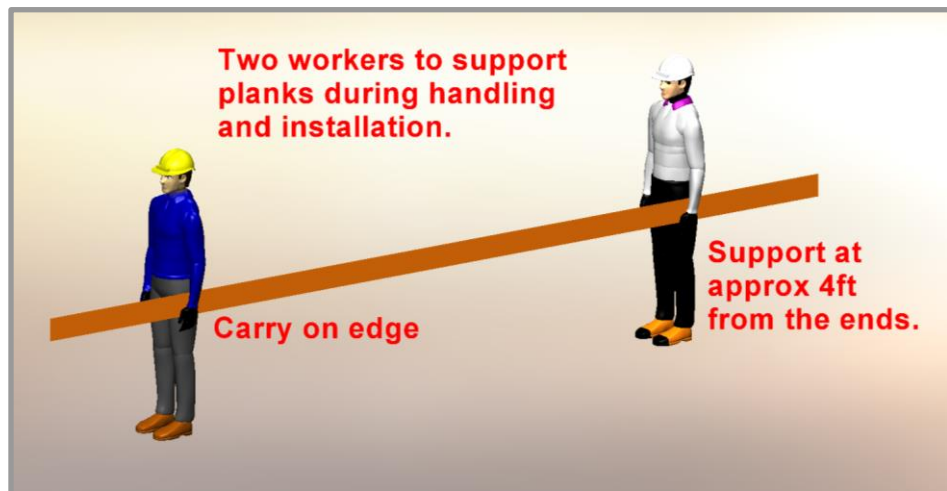
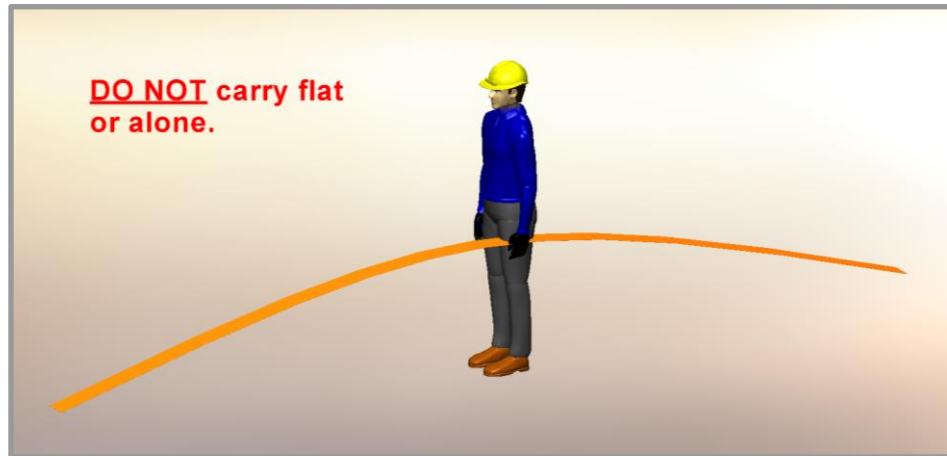

⚠️ Delivery, Storage & Handling ⚠️

- Always inspect the delivery for damage and contact LB ASAP if there are any issues: info@longboardproducts.com or 1-800-604-0343 and include your PO# and any pictures if possible. Longboard is not responsible for the installation of blemished or damaged material.
- Be sure to store the material flat, keep it dry, safe & secure and remain in unopened cartons until ready to be installed.
- Always wear appropriate PPE when handling products.

BLANK PAGE



Longboard Architectural Products Inc.
© Longboard Architectural Products Inc. All rights reserved.

Longboard® is a registered trademark of Longboard Architectural Products Inc.

Longboard
1777 Clearbrook Road
Abbotsford, BC V2T 8X8
Canada
longboardproducts.com

Every effort has been made to ensure that the information in these installation guidelines is accurate. Longboard is not responsible for printing or clerical errors.

For more information, contact client care at info@longboardproducts.com or call toll free 1-800-604-0343.