

PRIVACY BEAM SOFFIT

TYPICAL ISOMETRICS

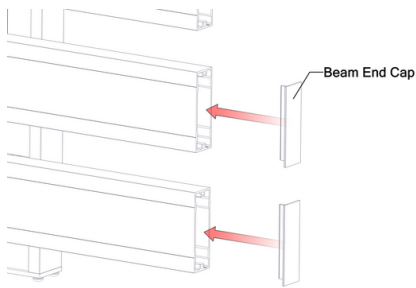

SINGLE POST

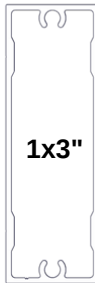

1x3"

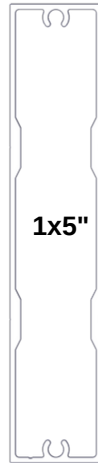

1x5"

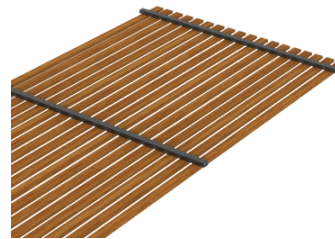

BEAM END CAP

PROFILES

1x3", 1x5" - Standard Lengths: 24'

COMPONENTS

Single Post, -Standard 24'
Beam End Cap, Post End Cap - (20pcs)
Spacer Bar (1", 12'), Spacer Block (100pcs)
Mounting Bracket - (100pcs)

FINISHES

Woodgrains, solid colors, naturally aged metals, special order. Custom solid color matching available (additional lead times apply).

PB_SO_IS_RC_V3

ATTACHMENT

Floating System attached with Mounting Brackets, End Frame System placed in posts and supported with Spacer Blocks
Spacer Bar - comes in 12ft lengths -cut for variable heights
Spacer Block - 1-1/2" spacer

BIM & CAD

RVT & DWG files available,
see website for details

LEAD TIME

Most Popular Finishes
-ready to ship within 1 week
Additional Finishes
-ready to ship within 14 weeks



info@longboardproducts.com
[longboardproducts.com](https://www.longboardproducts.com)
800 604 0343

TECHNICAL SPECIFICATIONS

PHYSICAL DATA

6063-T5 Extruded Aluminum
100% Recyclable
Warranty: Finish:15 year (standard)/20 year* (ultra) (*10 week lead time);
Aluminum: 50 year
Weight (lbs/lf): 0.7 (1X3); 1.1 (1X5)

TESTING

ICC-ESR 4183 Evaluation Report - Division: 05 00 00 - METALS
• Section: 05 50 00 - Metal Fabrications

LARR - Los Angeles Department of Building Safety (LADBS) accepts ICC-ES reports as proof of compliance

Florida Product Code: FL42008

Florida Building Code: Building
Florida Building Code: Residential

WUI (The Wildland-Urban Interface) - California Department of Forestry & Fire Protection Office of the State Fire Marshall Listing No. 8140-2286:0500



Fire Rating: Class A Non-Combustible by ASTM E136 & ASTM E84



Light reflectance (LRV): 5% (Black) Up to 73.2% (Ultra White)

Privacy Beam Soffit

Installation Guidelines

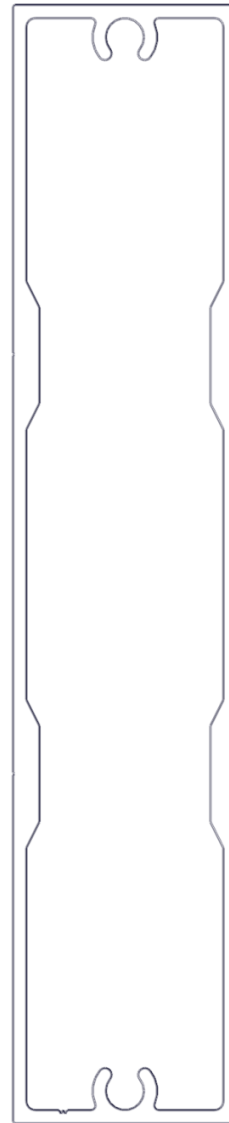
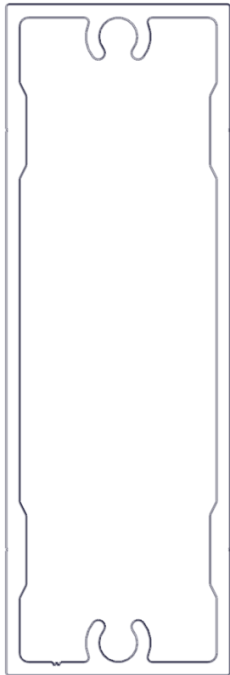

Table of Contents

Material Specifications	3
Finishes	3
Expansion and contraction	3
Material ordering and deliveries	3
Storage and handling	3
Cleaning	3
Warranty	3
Graffiti Cleaning	4
Components	5
Components (Typical)	5
Tools/Cutting/Fastening	6
Tools	6
Cutting	6
Fastening	7
Fastener types	7
Framing requirements	8
System Install	9
Perimeter and field area limitations	9
Component assembly overview	10
Floating system	10
End Frame system	11
Preparation drilling for install	12
Install steps	13
Floating system	13
End Frame system	14
Details	15
Butt-Joints	15
Appendix	16
Tables - Expansion & contraction	16
Tables – Design Pressure Tables	17
Handling and care of products	18
Blank Page	19
Contact Info	20

Material Specifications

Finishes

- Longboard Products are available in a wide range of powder coated finishes
- Custom solid colors are available upon request
- Longboard Products are not recommended for use on marine applications in direct contact with salt water

Longboard extruded products are produced 1" (25mm) oversized, as one end is drilled for the coating process, and both ends have 1/2" (12mm) of masking tape (woodgrains only) which must be cut off for best results. Longboard Cladding is to be installed outboard of a weather resistant barrier, including all flashings, following code, and building requirements.

Expansion & Contraction

Privacy Beam components expand & contract 1/4" (6mm) over 24' (7.3m) along the length, measured over a 30°C (54°F) temperature range. Due to this range of movement, Privacy Beam Fins /Battens should be installed with staggered butt-joints, leaving a 1/4" (6mm) min. gap, every 24' (7.3m) min.

See **Appendix for Tables 1 & 2, expansion/contraction calculations per foot/meter of material.**

Material Ordering & Delivery

-
- **Packaging:** Privacy Beams are sold in 24' lengths, 1x3 & 1x5.
End caps are sold by the box: 20 caps/bx
Single Posts are sold in 24' lengths
-
- **Shipping:** Most Popular Finishes -ready to ship within 1 week
Additional Finishes -ready to ship within 14 weeks
Delivered on 24' (7.3m) long skids weighing up to 2000 lbs. A mechanical lift with forks is required on site to receive the order.
-
- **QC:** Always inspect the delivery for damage and contact LB ASAP if there are any issues: info@longboardproducts.com or 1-800-604-0343 and include your PO# and any pictures if possible. Mark the delivery receipt as "damaged" and accept the delivery as-is. Longboard is not responsible for the installation of blemished or damaged material.

Storage & Handling

Be sure to store the material flat, keep it dry, safe & secure and remain in unopened cartons until ready to be installed. See **Appendix for proper handling and care instructions.**

Cleaning Recommendations

- Initial and periodic cleaning for best looking product
- Basic methods use a combination of moderate water pressure, soft sponge/brush and a mild detergent (Safe for your hands, safe for the product)

⚠ NEVER use aggressive acid or alkaline cleaners on Longboard finishes. Do not use cleaners containing Trisodium Phosphate, Phosphoric Acid, Hydrochloric Acid, Hydrofluoric Acid, Fluorides, or any other compound that is known to react with metal.

See *Cleaning Guide for full requirements & cleaning schedule:
longboardproducts.com/resources/care-maintenance.com

Warranty

Upon substantial completion of the project, register for warranty online here: longboardproducts.com/warranty

⚠ Registration is required for the warranty to be in effect.



Graffiti Removal

Standard Woodgrain 

Use Standard soap & water only

D2000 Solid Color

	Prosoco Cleaner	MEK Solvent
Permanent Marker	<input checked="" type="checkbox"/>	<input checked="" type="checkbox"/>
Oil Based Spray Paint	<input checked="" type="checkbox"/>	<input checked="" type="checkbox"/>
Water Based Spray Paint	<input checked="" type="checkbox"/>	<input checked="" type="checkbox"/>
Adhesive Tape	<input checked="" type="checkbox"/>	<input checked="" type="checkbox"/>

 MEK Solvent
 Prosoco Anti-Graffiti Cleaner

SPECIAL ORDER - EXT. LEAD TIMES CONTACT LB

Anti-Graffiti High Gloss Woodgrain

	MEK Solvent
Permanent Marker	<input checked="" type="checkbox"/>
Oil Based Spray Paint	<input checked="" type="checkbox"/>
Water Based Spray Paint	<input checked="" type="checkbox"/>
Adhesive Tape	<input checked="" type="checkbox"/>









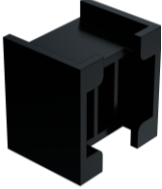

 MEK Solvent

Note: Cleaning the surface with a cleanser that is not diluted as per instructions, may result in damage to the coating.

Components

Components (Typical)







The Privacy Beam system consists of Beams attached to Single Posts and installed onto a support structure or exterior building envelope. For all LB components go to longboardproducts.com.

 <p>1x3 Beam (1" width) 1X3B.289</p>	 <p>1x5 Beam (1" width) 1X5B.289</p>	 <p>Beam End Caps (1" width) 1BEC.3, 1BEC.5</p>	 <p>Spacer Block (For 1x3 & 1x5) 2X2SB</p>
 <p>Single Post (1 1/2"x2") 2X2SP.289</p>	 <p>Single Post End Cap 2X2PC.2</p>	 <p>Post End Cap Screws #10-1 Pan Head (square drive) PECS</p>	 <p>Spacer Bar (1" width) 12' length - 1X2FB.145 1" length- 1X2FB.1 (100/Box) 3" length- 1X2FB.3 (100/Box)</p>
 <p>Mounting Bracket (100/Box) 3PSMB</p>	 <p>Mounting Bracket Screws #10-16x3/4 Tek Hex Head (200/Box) *Included x 2 with bracket</p>	 <p>Paint Pen TUP</p>	

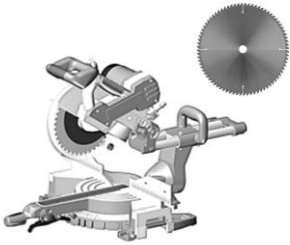
Tools/Cutting/Fastening

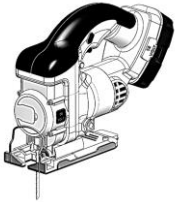
Tools

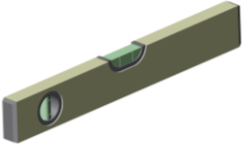
Commonly used tools for Privacy Beam install.

			
Table Saw with Carbide Metal Blade Non-ferrous 60-80T (for cutting aluminum)	Miter Saw with Carbide Metal Blade Non-ferrous 60-80T (for cutting aluminum)	Cordless Drill with clutch	Jig Saw (for protrusions)
			
Rubber Mallet (or Hammer)	Level	#2 Square Drive Bit (Roberston)	3/8" Hex Head Driver

Cutting

⚠ Always be sure to wear appropriate PPE: eye & hearing protection.

Cut battens using a Miter Saw and Table Saw always allowing for expansion & contraction. Trim the taped/drilled ends of all stock length material by at least **1/2" (12mm) each end** and discard.

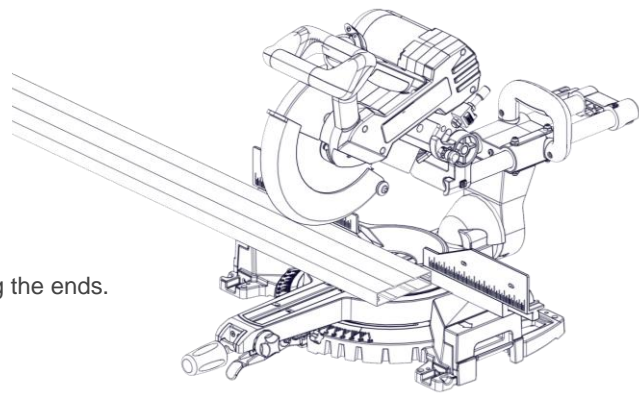

⚠ **DO NOT** Install Privacy Beams without trimming the ends.

Fastening

Longboard Privacy Beam consists of 1x3 & 1x5 extrusions which are installed onto single posts using mounting brackets for Floating system or spacer blocks for End Frame system. These posts are fastened with #12 fasteners (by others) to a solid secure support structure or substrate, sharp-point screws (for wood substrates) or self-drilling (for metal substrates).

Fasteners must be corrosion resistant and comply with all local building codes.

⚠ All fasteners should be suitable for exterior use and be compatible with the substrate type. **Fasteners should be anchored into a solid secure substrate.**

⚠ See Appendix for project specific fastener spacing: Tables 3 & 4

Fastener types

RECOMMENDED

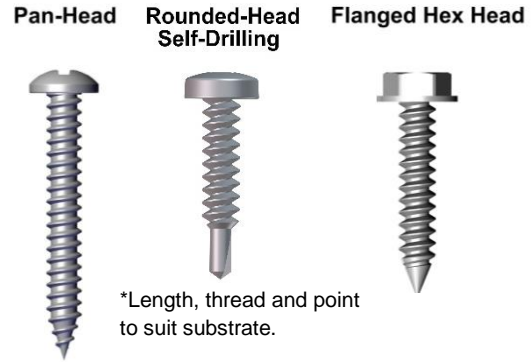

FLOATING SYSTEM			
SUBSTRATE	ANCHOR DESCRIPTION	MIN. EMBEDMENT	MIN. EDGE DISTANCE
WOOD MIN. S.G. =0.55	#12 WOOD SCREW	1-1/2"	1"
STEEL: MIN. 1/16" THICK, MIN. Fy =36 KSI	#12 SELF-DRILLING OR SELF-TAPPING SCREW (GRADE 5)	3 THREADS PENETRATION PAST METAL STRUCTURE	1/2"
ALUM.: MIN. 1/8", MIN. 6063-T5			
CONCRETE MIN. F'C =3000 PSI	3/16" ITW TAPCON	1-1/2"	1-7/8"
HOLLOW / GROUT-FILLED BLOCK PER C-90 MIN. F'C =2000 PSI	3/16" DEWALT ULTRACON+	1-1/4"	2"

Floating System

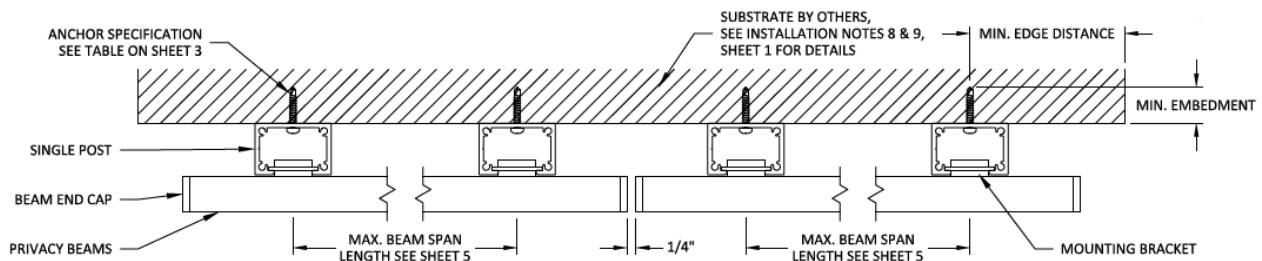

END FRAME SYSTEM			
SUBSTRATE	ANCHOR DESCRIPTION	MIN. EMBEDMENT	MIN. EDGE DISTANCE
WOOD MIN. S.G. =0.55	#12 WOOD SCREW	1-1/2"	1"
STEEL: MIN. 18 GA., MIN. Fy =36 KSI	#12 SELF-DRILLING OR SELF-TAPPING SCREW (GRADE 5)	3 THREADS PENETRATION PAST METAL STRUCTURE	1/2"
ALUM.: MIN. 1/8", MIN. 6063-T5			
CONCRETE MIN. F'C =3000 PSI	3/16" ITW TAPCON	1-1/2"	2"
HOLLOW / GROUT-FILLED BLOCK PER C-90 MIN. F'C =2000 PSI		1"	3"

End Frame System

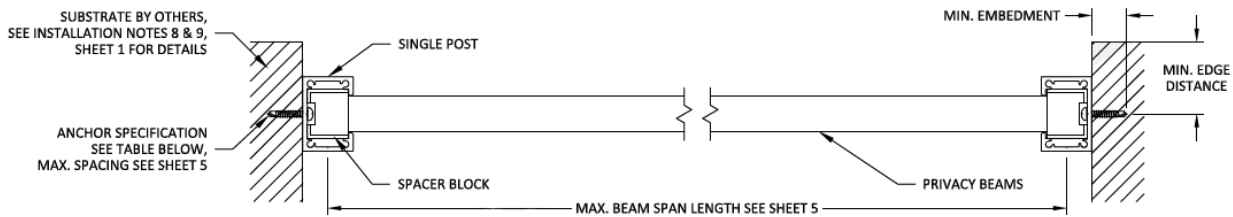

Framing requirements

Always consult your local building authority and follow local building code requirements. See Typical dimensions for sizes and weights of the Privacy Beam system.

Wood Framing

- Size: 2x4 minimum
- Spacing: 16" (406mm) O.C.

Metal Framing

- Gauge: 18 ga. minimum
- Spacing: 16" (406mm) O.C.

Concrete/CMU

When application calls for wood or metal furring over concrete and CMU use:

Wood Furring:

- Size: 2x2 minimum
- Type: Pressure treated lumber
- Spacing: 16" (406mm) O.C.

Metal Furring:

- Size: 18 ga. minimum
- Type: Hat channel, c-stud, or z-furring.
- Spacing: 16" (406mm) O.C.

System Install

Perimeter and field area limitations

Measure and layout your application area to consider Privacy Beam alignment with fixtures, penetrations, and adjacent walls, for desired appearance. The same methodology applies for vertical installations.

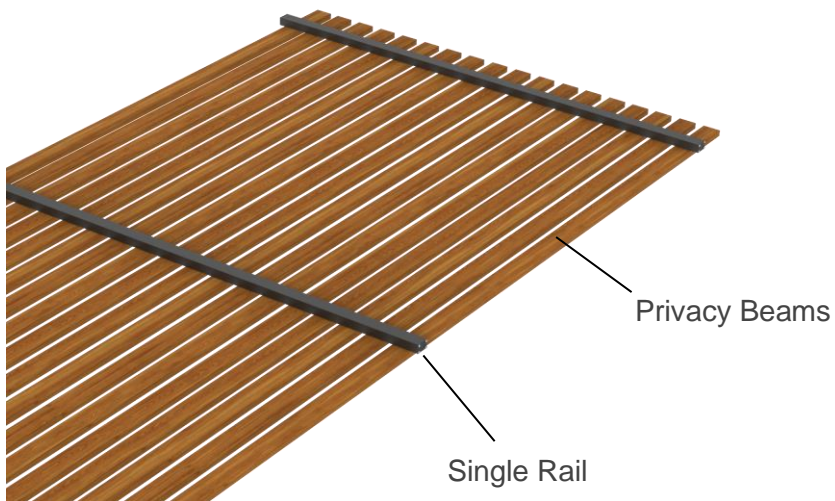
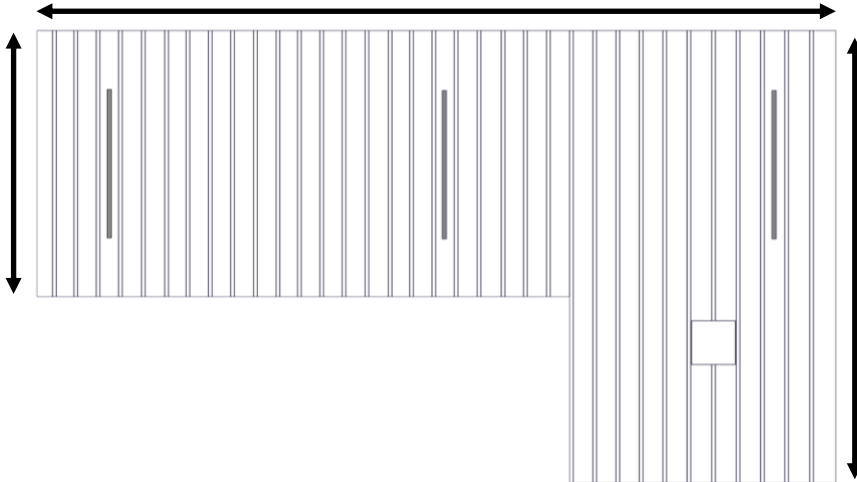

Component assembly overview

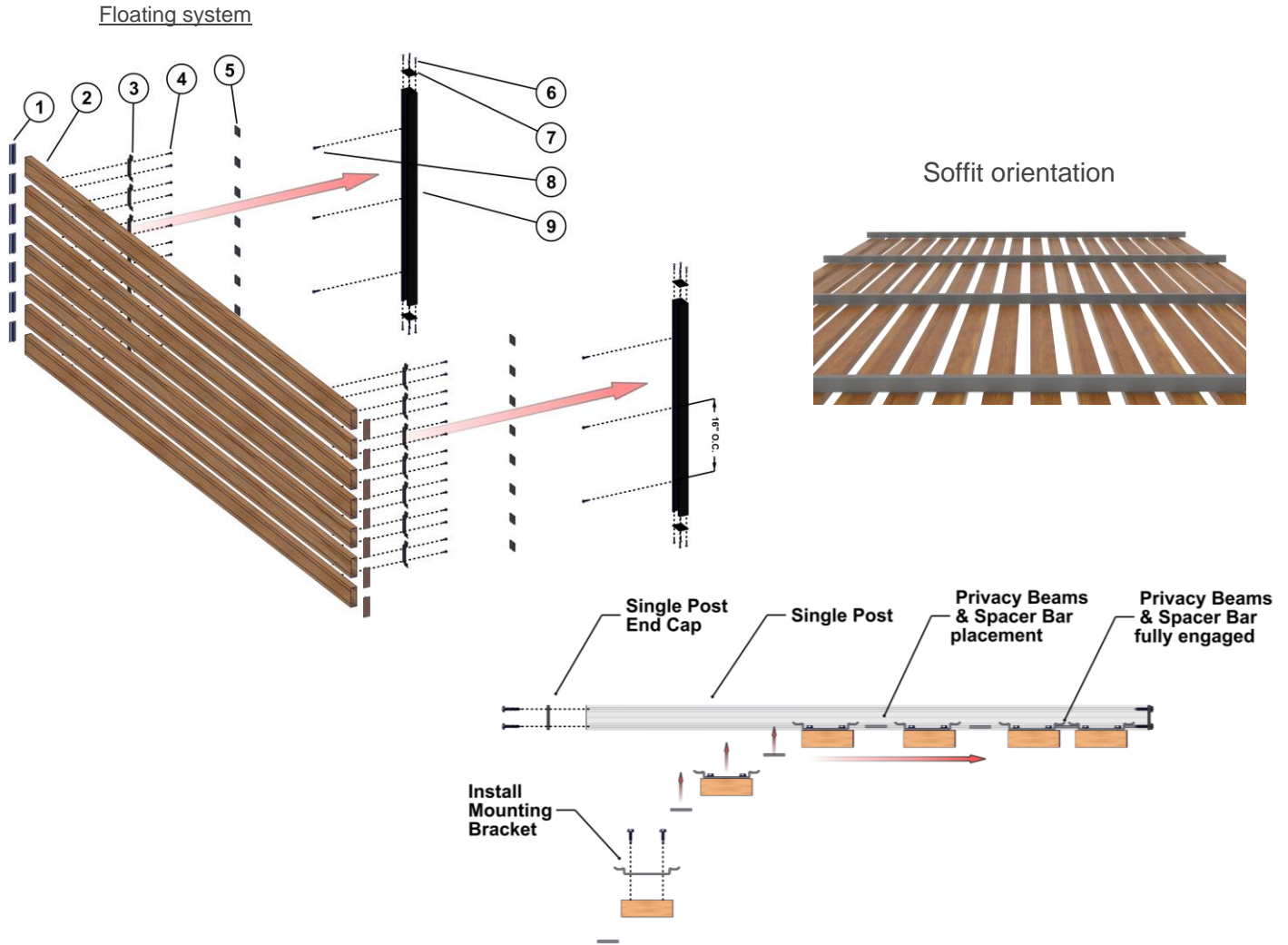

No.	Description	Details	SKU
1	End Cap	-End Caps are friction fit onto ends of the Privacy Beams	1BEC.3, 1BEC.5
2	Privacy Beam	-1"x3" Beam, 1"x5" Beam	1X3B.289, 1x5B.289
3	Mounting Bracket	-Secured onto Beam, (100/box)	3PSMB
4	#10-16x3/4 Tek Hex Head Screw	-For securing the bracket to the Beam Included x 2 with bracket, (200/box)	Included with Mounting Bracket
5	Spacer bar (1" piece)	-For spacing between the Beams 12' length, 1" length- (100/Box), 3" length- (100/Box)	1X2FB.145, 1X2FB.1, 1X2FB.3
6	#10-1 Pan Head Screw	-For securing the Single Post End caps (sold separately)	PECS
7	Single Post End Cap	-Secured onto the end of the Single Posts	2X2PC.2
8	#12 Fastener (by others)	-Used to secure the Posts to the structure. For spacings subject to loading see tables 3 & 4 in appendix.	N/A
9	Single Post	-Installed at 6' O.C. typical spacing, Beams are connected to the posts via the mounting bracket	2X2SP.289

End Frame system

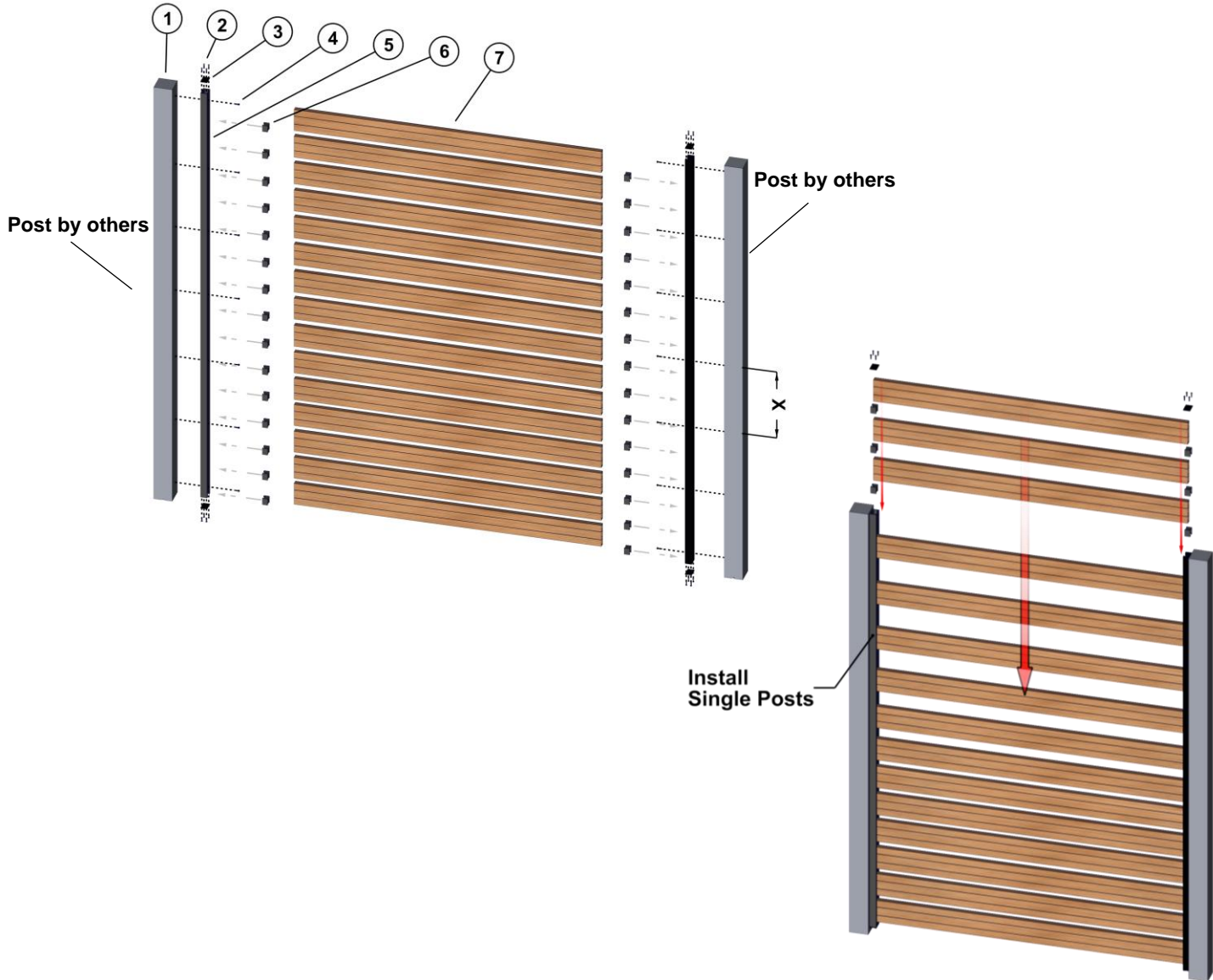

No.	Description	Details	SKU
1	Post or structural member	-By others	N/A
2	#10-1 Pan Head Screw	-For securing the Single Post End caps (sold separately)	PECS
3	Single Post End Cap	-Secured onto the end of the Single Posts	2X2PC.2
4	#12 Fastener (by others)	-Used to secure the Posts to the structure. For spacings subject to loading see tables 3 & 4 in appendix.	N/A
5	Single Post	-Installed at 6' O.C. typical spacing, Beams are connected to the posts via the mounting bracket	2X2SP.289
6	Spacer Block	-For spacing between the Beams (1" spacing)	2X2SB
7	Privacy Beam	-1"x3" Beam, 1"x5" Beam	1X3B.289, 1x5B.289

Preparation drilling for Install

To prepare the Privacy Beam system for install, predrill the single posts with 1/2" holes every 16" O.C. typical with the first hole approx. 2" in from the end.

*For fastener max. spacing (X), see tables 3 & 4 in Appendix for project specific design pressure.

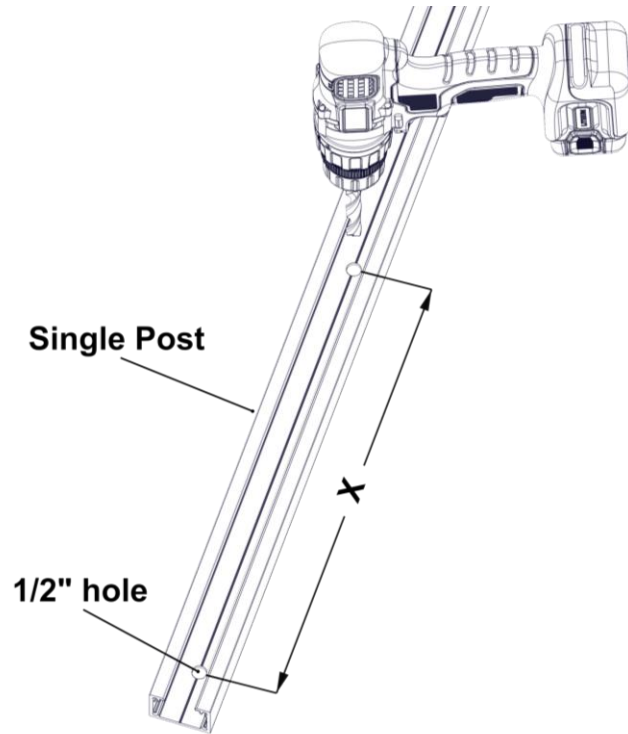

Anchoring for End Frame System

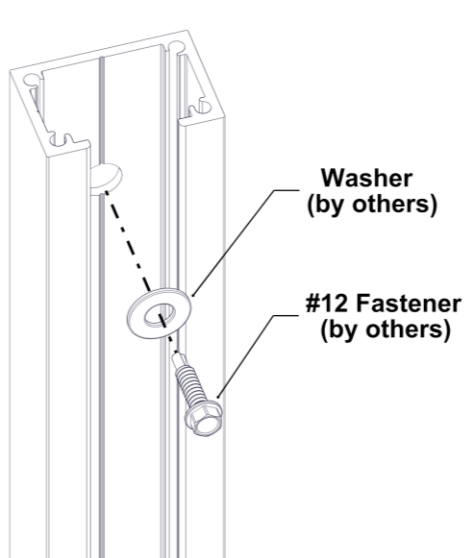

Anchoring for Floating System

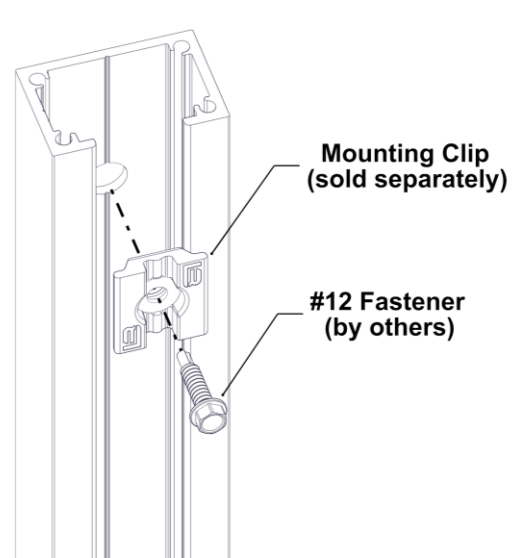

Install steps

Floating system

Step 1

Layout and install predrilled Privacy Posts onto secure structure. It is good practice to check your installation every 2-3 rows for level/plumb and flat/straight, for best result.

Note: Be sure to fasten in the center of the 1/2" holes to allow for movement each way. Hard fasten near the center of each length to prevent migration of the material over time.



Step 2

Install bottom Single Post End Cap and Spacer Bar.

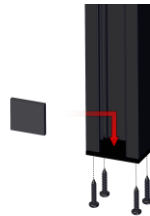

Step 3

Fasten Mounting Brackets onto Privacy Beams at desired spacing for the connection to the Single Posts. Use the Die lines as guides for the Mounting Bracket positioning.



Step 4

Install Privacy Beams onto the Single Posts locking into place and continue until all are in place.

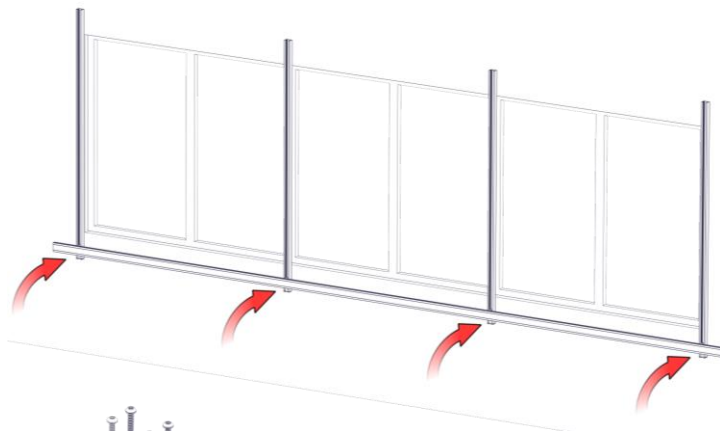
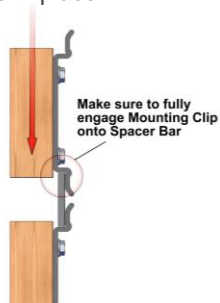

Step 5

To finish, install the last Spacer Bar and Single Post End Cap. Then install Privacy Beam End Caps.

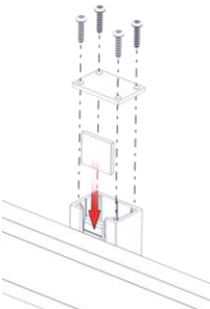

Install steps

End Frame system

Step 1

Install bottom Single Post End Cap.

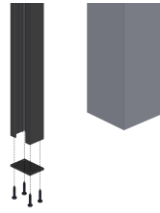

Step 2

Install predrilled Privacy Posts onto secure structure. It is good practice to check your installation every 2-3 rows for level/plumb and flat/straight, for best result.

Note: Be sure to fasten in the center of the 1/2" holes to allow for movement each way. Hard fasten near the center of each length to prevent migration of the material over time.

***For fastener max. spacing (X), see tables 3 & 4 in Appendix for project specific loading.**

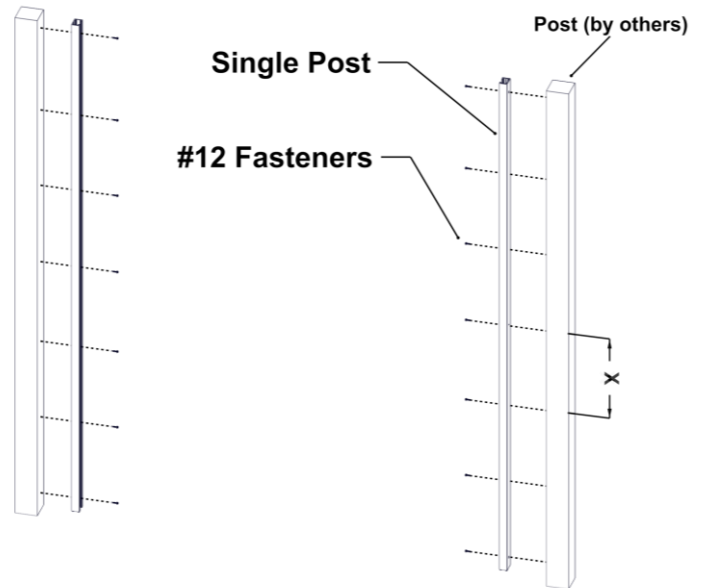

Step 3

Place Spacer Block into Post from top of Post and slide down to required location.

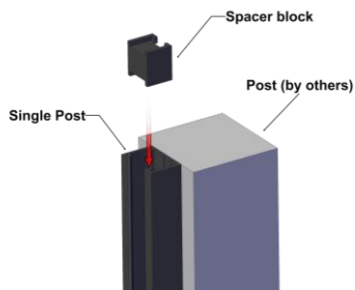

Step 4

Cut and place Privacy Beam into Single Posts. Then another Spacer Block and Beam and repeat.

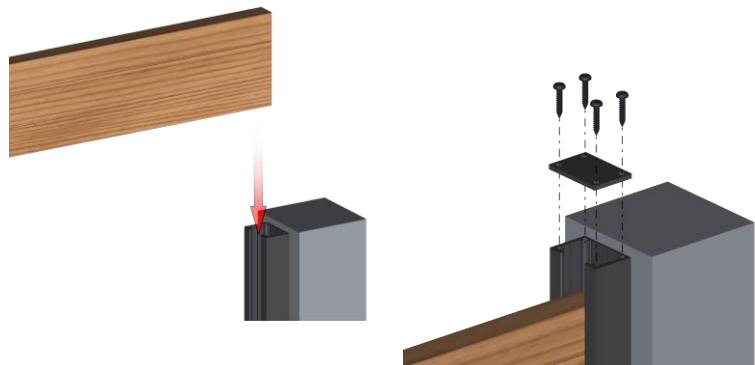

Step 5

To finish, install the Single Post End Cap.

Details

Butt-Joints

- ▲ **BUTT-JOINTS.** When installing butt-joints, ensure to leave a 1/4" (6mm) min. gap. every 24' (7.3m) min. (See Detail A).

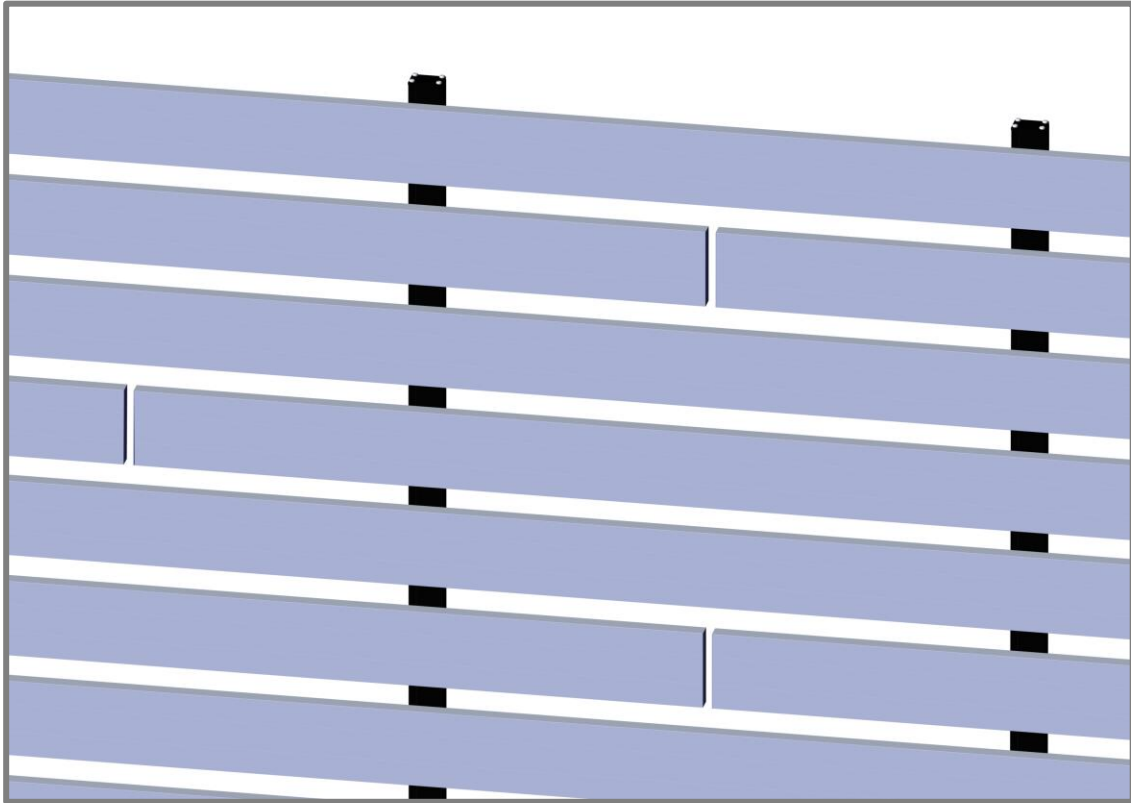

Detail A

Appendix

Expansion and Contraction Tables

TABLE 1 - IMPERIAL

		AVERAGE TEMPERATURE AT TIME OF CUTTING & INSTALLATION											
°C		-50	-40	-30	-20	-10	0	10	20	30	40	50	
°F		-58	-40	-22	-4	14	32	50	68	86	104	122	
MIN/MAX POST CONSTRUCTION TEMP.	°C	°F	EXPANSION OR CONTRACTION (INCH/FOOT)										
	-50	-58	0.000	-0.003	-0.005	-0.008	-0.011	-0.014	-0.016	-0.019	-0.022	-0.024	-0.027
	-40	-40	0.003	0.000	-0.003	-0.005	-0.008	-0.011	-0.014	-0.016	-0.019	-0.022	-0.024
	-30	-22	0.005	0.003	0.000	-0.003	-0.005	-0.008	-0.011	-0.014	-0.016	-0.019	-0.022
	-20	-4	0.008	0.005	0.003	0.000	-0.003	-0.005	-0.008	-0.011	-0.014	-0.016	-0.019
	-10	14	0.011	0.008	0.005	0.003	0.000	-0.003	-0.005	-0.008	-0.011	-0.014	-0.016
	0	32	0.014	0.011	0.008	0.005	0.003	0.000	-0.003	-0.005	-0.008	-0.011	-0.014
	10	50	0.016	0.014	0.011	0.008	0.005	0.003	0.000	-0.003	-0.005	-0.008	-0.011
	20	68	0.019	0.016	0.014	0.011	0.008	0.005	0.003	0.000	-0.003	-0.005	-0.008
	30	86	0.022	0.019	0.016	0.014	0.011	0.008	0.005	0.003	0.000	-0.003	-0.005
	40	104	0.024	0.022	0.019	0.016	0.014	0.011	0.008	0.005	0.003	0.000	-0.003
	50	122	0.027	0.024	0.022	0.019	0.016	0.014	0.011	0.008	0.005	0.003	0.000

TABLE 2 - METRIC

		AVERAGE TEMPERATURE AT TIME OF CUTTING & INSTALLATION											
°C		-50	-40	-30	-20	-10	0	10	20	30	40	50	
°F		-58	-40	-22	-4	14	32	50	68	86	104	122	
MIN/MAX POST CONSTRUCTION TEMP.	°C	°F	EXPANSION OR CONTRACTION (MM/METER)										
	-50	-58	0.000	-0.230	-0.460	-0.690	-0.920	-1.150	-1.380	-1.610	-1.840	-2.070	-2.300
	-40	-40	0.230	0.000	-0.230	-0.460	-0.690	-0.920	-1.150	-1.380	-1.610	-1.840	-2.070
	-30	-22	0.460	0.230	0.000	-0.230	-0.460	-0.690	-0.920	-1.150	-1.380	-1.610	-1.840
	-20	-4	0.690	0.460	0.230	0.000	-0.230	-0.460	-0.690	-0.920	-1.150	-1.380	-1.610
	-10	14	0.920	0.690	0.460	0.230	0.000	-0.230	-0.460	-0.690	-0.920	-1.150	-1.380
	0	32	1.150	0.920	0.690	0.460	0.230	0.000	-0.230	-0.460	-0.690	-0.920	-1.150
	10	50	1.380	1.150	0.920	0.690	0.460	0.230	0.000	-0.230	-0.460	-0.690	-0.920
	20	68	1.610	1.380	1.150	0.920	0.690	0.460	0.230	0.000	-0.230	-0.460	-0.690
	30	86	1.840	1.610	1.380	1.150	0.920	0.690	0.460	0.230	0.000	-0.230	-0.460
	40	104	2.070	1.840	1.610	1.380	1.150	0.920	0.690	0.460	0.230	0.000	-0.230
	50	122	2.300	2.070	1.840	1.610	1.380	1.150	0.920	0.690	0.460	0.230	0.000

Ultimate Pressure Tables

TABLE 3

1X3 BEAM		MAX ANCHOR SPACING FOR POSTS (IN)					
		FLOATING SYSTEM			END FRAME SYSTEM		
ALLOWABLE SPAN (FT)	ULTIMATE PRESSURE (PSF)	WOOD	STEEL / ALUM.	CONCRETE / MASONRY	WOOD	STEEL / ALUM.	CONCRETE / MASONRY
4	72	15.5	6	6	6	12	6
6	42						
7	24	24	12	12	12	24	12
8	18						

TABLE 4

1X5 BEAM		MAX ANCHOR SPACING FOR POSTS (IN)					
		FLOATING SYSTEM			END FRAME SYSTEM		
ALLOWABLE SPAN (FT)	ULTIMATE PRESSURE (PSF)	WOOD	STEEL / ALUM.	CONCRETE / MASONRY	WOOD	STEEL / ALUM.	CONCRETE / MASONRY
4	72	15.5	6	6	6	14	6
6	36	21	8	8	8	20	8
7	18	24	14	14	14	24	12

Proper Handling of Longboard Products



To help avoid injury and product damage, Longboard products require proper handling to and from storage areas during installation. When carrying or installing any products it is recommended that they be moved or carried by at least two people with each support point approximately 4ft from the ends. **Carrying products without proper support can cause excessive bending which may damage the appearance or finish of the product.** Any short cut lengths should also be carried on edge while supporting the material. See below for details.

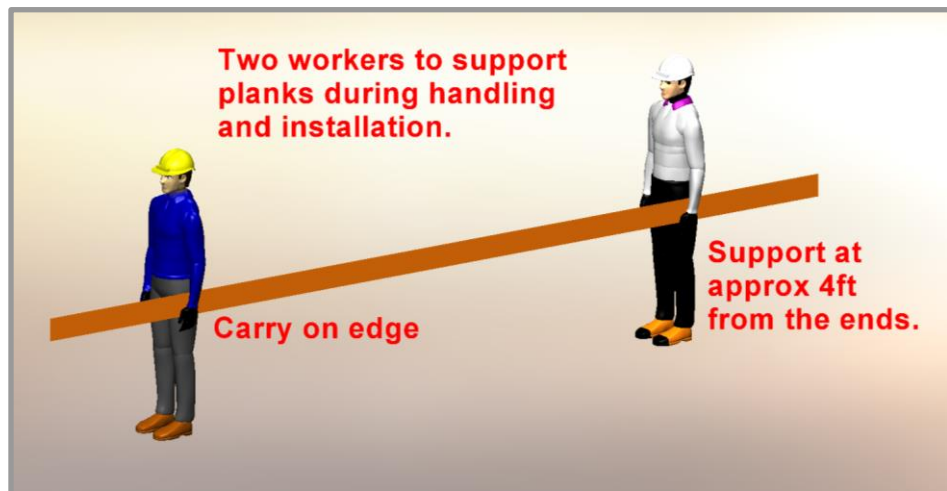
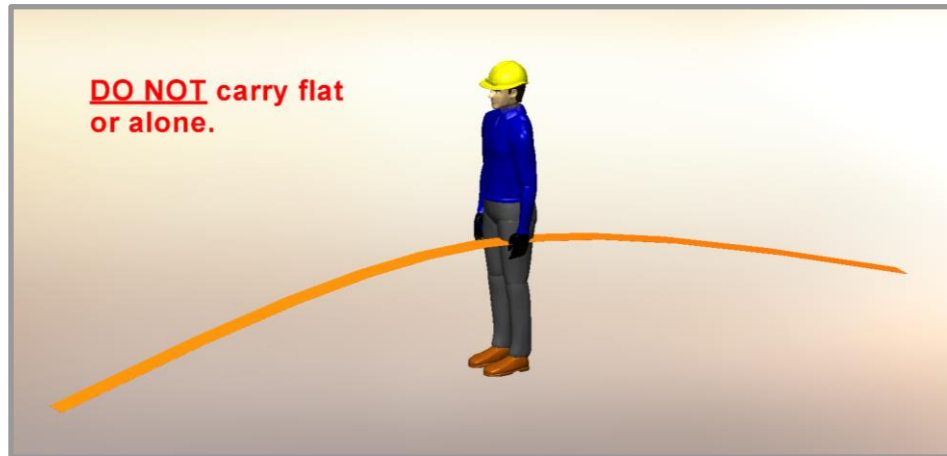

⚠️ Delivery, Storage & Handling ⚠️

- Always inspect the delivery for damage and contact LB ASAP if there are any issues: info@longboardproducts.com or 1-800-604-0343 and include your PO# and any pictures if possible. Longboard is not responsible for the installation of blemished or damaged material.
- Be sure to store the material flat, keep it dry, safe & secure and remain in unopened cartons until ready to be installed.
- Always wear appropriate PPE when handling products.

BLANK PAGE



Longboard Architectural Products Inc.
© Longboard Architectural Products Inc. All rights reserved.

Longboard® is a registered trademark of Longboard Architectural Products Inc.

Longboard
1777 Clearbrook Road
Abbotsford, BC V2T 8X8
Canada
longboardproducts.com

Every effort has been made to ensure that the information in these installation guidelines is accurate. Longboard is not responsible for printing or clerical errors.

For more information, contact client care at info@longboardproducts.com or call toll free 1-800-604-0343.



Tongue & Groove Systems

V-Groove Planks

Size	* 48 sq. ft. box quantities		‡ 96 sq. ft. box quantities	
	12' *	24' *	12' Perf *	24' Perf *
2½"	3V.145	-	3VP.145	-
4"	4V.145	4V.289	-	-
6"	6V.145	6V.289	6VP.145	6VP.289

Smooth Planks

Size	12' *	24' *	12' Perf *	24' Perf *
6"	6PSP.145	6PSP.289	6PSPP.145	6PSPP.289

Channel Planks

Size	12' *	24' *	12' Perf *	24' Perf *
6"	6CH.145	6CH.289	-	-

Bevel Planks

Size	12' *	24' *	12' Perf *	24' Perf *
6" Single	6SB.145	6SB.289	-	-
6" Triple	6TB.145	6TB.289	-	-

Castellation Planks

Size	12' *	24' *	12' Perf *	24' Perf *
4"	4CA.145	4CA.289	-	-
8"	8CA.145	8CA.289	-	-

Trim Components

Type	Style	Product	Dimensions	SKU
Starter	Precision	Starter J-Track	(5/8") - 12'	1SJT.145
Starter	Traditional	Starter Strip	(1-7/8") - 12'	2SS.145
Starter	Traditional	Back-to-Back Starter Strip	(1-1/4")	2BTBSS.145
J-Track	Precision	Two Piece J-Track	(5/8") - 12'	1X1JT.145
J-Track	Precision	J-Track	(5/8") - 12'	1JT.145
J-Track	Craftsman	J-Track	(7/8") - 12'	JT23.145
J-Track	Craftsman	Two Piece J-Track	(7/8") - 12'	JT23S.145
J-Track	Traditional	Two Piece J-Track	(1-3/8") - 12'	1X2JT.145
Corner	Precision	Outside Corner	(3/16") - 12'	05OC.145
Corner	Craftsman	Inside Corner	(3/4") - 12'	1IC.145
Corner	Craftsman	Outside Corner	(1") - 12'	1OC.145
Corner	Traditional	Corner Set	(2") - 12'	2CORS.145
Corner	Traditional	3" Smooth	(3") - 24'	3SCP.289
Corner	Traditional	3" V-Groove	(3") - 24'	3SVP.289
Reveal	Precision	Flat Reveal	(1/2") - 12'	1FR.145
Reveal	Precision	T&G Flat Reveal	(1/2") - 24'	1TGFR.289
Reveal	Craftsman	U-Reveal Set	(3/4") - 12'	1URS.145
Reveal	Craftsman	T&G U-Reveal	(3/4) - 24'	1TGURK.289
Reveal	Traditional	U-Reveal Set	(1-1/2") - 12'	2URS.145
Reveal	Traditional	Flat Reveal Set	(1-1/2") - 12'	2FRS.145
Reveal	Traditional	T&G U-Reveal	(1 1/2") - 24'	2TGURK.289
Reveal	Traditional	Offset Flat Reveal Set, J-Track Base	(2") - 12'	2OFFJ.145
Reveal	Traditional	Offset Flat Reveal Set, Termination Base	(2") - 12'	2OFFT.145
Termination	Precision	Termination Set	(5/8") - 12'	1TS.145
Termination	Craftsman	Termination Set	(7/8") - 12'	TS23S.145
Termination	Traditional	Termination Set	(1-3/8") - 12'	2TS.145
Compression Joints	Traditional	Compression Joint	(1-3/8") - 24'	2CJ.289



V-Groove Planks



Smooth Planks



Channel Planks



Perforated Planks



Bevel Planks



Castellation Planks



Butt Joint Fastening Kit



Quick Screen Clips



U-Shim



Touch-up Pens

Accessories

Product	Qty	SKU
Quick Screen Clips	1750, box	CLIP.N1750
Quick Screen Clips	100, bag	CLIP.N100
1/16" U-SHIM	250, bag	SHIM.1001
Butt-Joint Fastening Kit (6")	20 kits, bag	TGBJKIT
Touch Up Pens	N/A	TUP

Reach out to confirm color with account manager.



Precision Starter J-Track



Traditional Starter Strip



Traditional Back-to-Back Starter Strip



Precision Two-Piece J-Track

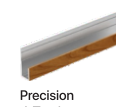

Precision J-Track



Craftsman J-Track



Craftsman Two Piece J-Track

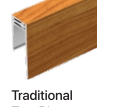

Traditional Two Piece J-Track

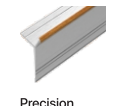

Precision Outside Corner

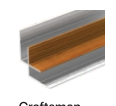

Craftsman Inside Corner

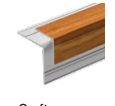

Craftsman Outside Corner



Traditional Corner Set



Traditional 3" Smooth Corner



Traditional 3" V Groove Corner

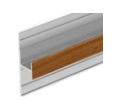

Precision Flat Reveal



Precision T&G Flat Reveal

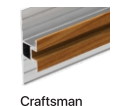

Craftsman U-Reveal Set



Craftsman T&G U-Reveal



Traditional U-Reveal Set



Traditional Flat Reveal Set

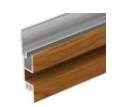

Traditional T&G U-Reveal



Traditional Offset Flat Reveal Set, J-Track Base



Traditional Offset Flat Reveal Set, Termination Base



Precision Termination Set



Craftsman Termination Set



Traditional Termination Set



Traditional Compression Joint

Link & Lock™ Battens

Size	12'	24'	End Caps (20/box)	End Mounts (20/box)
2"	2X2LL.145	2X2LL.289	2LLEC.2	2LLEM.2
4"	2X4LL.145	2X4LL.289	2LLEC.4	2LLEM.4
6"	2X6LL.145	2X6LL.289	2LLEC.6	2LLEM.6
8"	2X8LL.145	2X8LL.289	2LLEC.8	2LLEM.8

Link & Lock™ HD Battens

4"	2X4LLHD.145	2X4LLHD.289	2LLHDEC.4	2LLHDEM.4
6"	2X6LLHD.145	2X6LLHD.289	2LLHDEC.6	2LLHDEM.6
8"	2X8LLHD.145	2X8LLHD.289	2LLHDEC.8	2LLHDEM.8

Link & Lock™ Box Battens

4 x 4"	4X4LL.145	4X4LL.289	4LLEC.4	-
4 x 6"	4X6LL.145	4X6LL.289	4LLEC.6	-

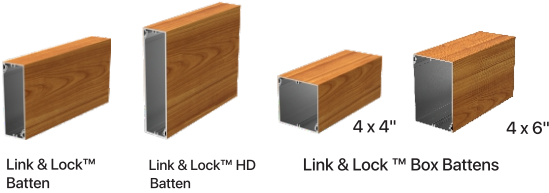

Link & Lock™ Batten

Link & Lock™ HD Batten

Link & Lock™ Box Battens

Mounting Accessories	Qty	SKU
Link & Lock Mounting Clip	48, bag	LLMC.N48
Link & Lock™ Isolation Washer	48, bag	FAST.5003.BOX48
Dewalt® 1/2" Pilot Point Drill Bit	1	DRILLBT.05
24' Link & Lock Internal Stiffener	1	LLSTIFF.289
3M® Double Sided Adhesive Tape - 108'	1, roll	LLTAPE.1296

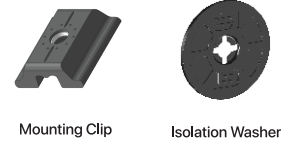

Mounting Clip

Isolation Washer



Dewalt® Drill Bit

Internal Stiffener

Link & Lock™ Mounting Brackets

Product	Single	Dual
45° LEFT FIXED	LLMBK.45LF	LLMDK.45LF
45° RIGHT FIXED	LLMBK.45RF	LLMDK.45RF
90° CENTER FIXED	LLMBK.90F	LLMDK.90F
45° LEFT SLIDING	LLMBK.45LS	LLMDK.45LS
45° RIGHT SLIDING	LLMBK.45RS	LLMDK.45RS
90° CENTER SLIDING	LLMBK.90S	LLMDK.90S

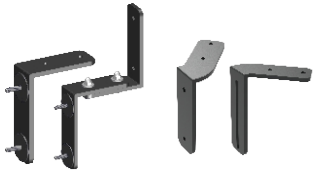

Single / Dual

Fixed / Sliding

Link & Lock™ Mounting Brackets

Privacy Beam System

Size	Product	24'	End Caps (20/box)
1x3"	Privacy Beam	1X3B.289	1BEC.3
1x5"	Privacy Beam	1X5B.289	1BEC.5
2x2"	Single Post	2X2SP.289	2X2PC.2
2x3"	Double Post	2X3DP.289	2X3PC.3

Mounting Accessories	Qty	SKU
Spacer Block	100, box	2X2SB.N100
1" Spacer Bar Stock Length	1	1X2FB.145
1x3" Spacer Bar	100, box	1X2FB.1
1x5" Spacer Bar	100, box	1X2FB.3
3" Mounting Bracket	100, box	3PSMB.1
#10 Black Screws	100, box	PECS.N100

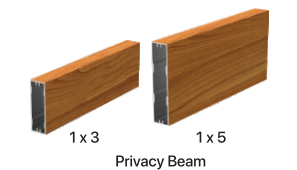

1 x 3

1 x 5

Privacy Beam

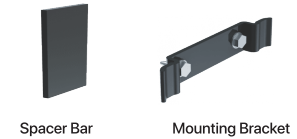

Spacer Bar

Mounting Bracket

Finishes

Woodgrains

Woodgrain	15 Year Finish Warranty	20 Year Finish Warranty
Beechwood	15BEE	-
Black Oak	15BKO	-
Birchwood	15BWD	-
Blonde Oak	15BOK	-
Burnt Cherry	15BCY	-
Dark Acacia	15DAC	20DAC
Dark Antique Oak	15DAO	-
Dark Bamboo	15DBB	20DBB
Dark Cherry	15DCY	20DCY
Dark Fir	15DFR	20DFR
Dark Knotty Pine	15DKP	20DKP
Dark National Walnut	15DNW	20DNW
Dark Olive	15DOL	-
Dark Walnut	15DWL	-
Driftwood	15DWO	-
Grey Douglas Fir	15GDF	-
Grey Hemlock	15GHL	-
Italian Rosewood	15IRW	20IRW
Light Bamboo	15LBB	20LBB
Light Cherry	15LCY	-
Light Fir	15LFR	20LFR
Light National Walnut	15LNW	-

Woodgrain	15 Year Finish Warranty	20 Year Finish Warranty
Light Oak	15LOK	-
Light Olive	15LOL	-
National Mahogany	15NMH	20NMH
Rock Elm	15REM	-
Southern Yellow Pine	15SYP	-
Table Walnut	15TWL	20LFR
Western Cedar	15WCD	-
White Oak	15WOK	-

Achieve your Vision.

We offer products in a variety 20+ stocked solid color and 20+ stocked woodgrain and speciality finishes that can be manufactured and shipped timely.

If a custom finish is required, we will work with our industry leading coating suppliers to develop a custom finish solution. All finishes are rigorously tested for corrosion and weathering resistance to ensure that it will stand up and deliver superior performance in the built environment.

Solid & Specialty

Solid & Specialty	15 Year Finish Warranty	20 Year Finish Warranty
Alabaster	15ALB	-
Baked Clay	15BCL	-
Bedrock	15BRK	-
Biscotti	15BIS	20BIS
Bone White	15BWH	20BWH
Brownstone	15BST	-
Burnt Sienna	15BSN	20BSN
Chili Pepper	15CHP	20CHP
Classic Bronze	15CBZ	20CBZ
Copper Penny	15CPE	20CPE
Dark Brown	15DBR	20DBR
Imperial Slate	15ISL	20ISL
Limestone	15LST	-
Medium Blue	15MBL	20MBL
Moonstone	15MOO	20MOO
Onyx Black	15OBL	20OBL
Pebble	15PEB	-
Portland Stone	15PST	-
Relicstone	15RST	-
Shale	15SHA	20SHA
Slate Grey	15SGR	20SGR
Ultra White	15UWH	20UWH
Venus	15VEN	20VEN

Naturally Aged Metals

Naturally Aged Metals	15 Year Finish Warranty	20 Year Finish Warranty
Brooklyn	15BRK	-
Eiffel	15EIF	-
Empire	15EMP	-
Golden Gate	15GGA	-
Liberty	15LIB	-



Scan the QR code to explore our Finishes on our Website

Contact us to speak to a trusted advisor to discuss your project goals and design needs.

Finish Options

Achieve your vision.

Whether creating a space that offers the warmth and appearance of Woodgrains, or the modern industrialized look of Naturally Aged Metals, we have a finish option for you.

Require a custom finish or color? Our experienced color-matching team can make it a reality!

Contact us to confirm lead times for orders greater than 15k sq.ft in the Most Popular Finishes category.

Longboard Finish Classification

Type: Woodgrain / Solid / Metallic / Speckle / Naturally Aged Metal

Surface: Smooth / Textured

Sheen: Matte / Satin / Glossy

Performance: AAMA 2604 / AAMA 2605

Finish Warranty: 15 Year / 20 Year



Click / Scan the QR code to check our latest lead times and explore available options!

Woodgrains

Longboard's woodgrain finishes have a slight texture with matte sheen.



Solid & Specialty

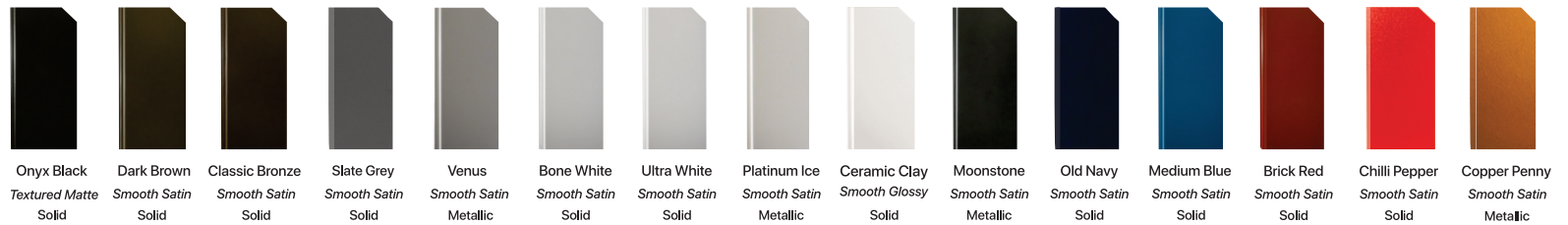

Speckle



Naturally Aged Metals



Print, Screens, and our pictures do not accurately reflect aspects of our finishes – textures, sheen, woodgrain hues, etc. Always order a physical sample before purchase! Our Color Bars swatches and samples will provide an accurate representation.

If a custom finish is required, we will work with our industry leading coating suppliers to develop a custom finish solution. All finishes are rigorously tested for corrosion and weathering resistance to ensure that it will stand up and deliver superior performance in the built environment.

We perform accelerated weathering testing in our onsite laboratory and work closely with coating suppliers to review weathering results of finishes undergoing natural Florida exposure testing. Our disciplined approach to powder coating, quality and process control distinguishes it as industry leading product manufacturer and ensures that its premium products stay looking beautiful for many, many years.

15 Year Non-Prorated Powder Coating Finish - 50 Year Non-Prorated Extruded Aluminum Profiles [Limited Warranty]
Warranty granted to (building owner):

Longboard Architectural Products Inc. ("Longboard," "The Company") products as identified by the Product Codes listed will conform to the standards set out in Clause 1 and Clause 2 of this Warranty, subject to the terms and conditions set out in Clause 3 and 4 of this Warranty.

Product codes: Product description:

Finish:	

Install contractor	
Project name	
Project address	
Address 2	Install start date
Date of substantial completion	

This Pinnacle Warranty is only valid for applications within Canada and USA. All applications outside of Canada and USA are required to contact Longboard for assistance.

- Clause 1**
Extruded Aluminum Profile(s) with Powder Coat Finish Longboard expressly warrants that its product line is free from manufacturing defects in material or workmanship.
- 1.1 When product is applied according to Longboard Instructions and properly maintained, such product is guaranteed against the following:
 - 1.2 Buckling: The product itself will be free of any buckling that is not associated with the substrate and/or structure to which the Longboard system is attached. For the purpose of this warranty, buckling shall be defined as warping of the product(s) exceeding one sixteenth of an inch out of plane per linear foot.
 - 1.3 Corrosion: When installed in normal atmospheric conditions according to Longboard Instructions and properly maintained, such product is further guaranteed against rusting and corroding. Subject to the limitations set out in Clause 3 and 4.
 - 1.4 What we will do: If, during the fifteen (15) year Limited Warranty Period on the powder coating finish, the Product is defective in material or workmanship, Longboard will, in its sole discretion, either repair or replace the defective portion of the Product.
 - 1.5 What we will do: If, during the fifty (50) year Limited Warranty Period on the extruded aluminum profiles, the Product is defective in material or workmanship, Longboard will, in its sole discretion, either repair or replace the defective portion of the Product.
 - 1.6 After the 15th year, this Limited Warranty on the powder coated finish will expire and shall no longer be applicable.
 - 1.7 After the 50th year, this Limited Warranty on the aluminum extruded profile(s) will expire and shall no longer be applicable.
 - 1.8 Longboard replacement of the defective Product or reimbursement of this Limited Warranty is the exclusive remedy for the Covered Person for any defect in materials or workmanship. The Company will pay for all reasonable costs including material and labor as it relates to the repair and/or replacement of the defective Product.
- Clause 2**
Product Finish - AAMA 2604 Performance Specification
- 2.1 During the first fifteen (15) years of this warranty:
 - 2.2 Checking/Cracking: No visible checking or cracking of the product finish on the building.
 - 2.3 Chalking Resistance: No chalking of the product finish on the building in excess of that represented by No.8 rating based on ASTM D4214.
 - 2.4 Color Retention: No color change of the product finish on the building greater than 5 (five) CIE LabΔE units calculated in accordance with ASTM 2244 Section 6.3. Color change shall be measured on the exposed paint surface which has been cleaned of oil, grease, chalk, oxidized film or other contaminants, corresponding values shall be measured on the control panel.
 - 2.5 Gloss Retention: Coated surface will exhibit gloss retention of a minimum of 30% of the original. Gloss retention shall be measured on the exposed paint surface which has been cleaned of oil, grease, chalk, oxidized film or other contaminants, corresponding values shall be measured on the control panel.
- Clause 3**
- 3.1 Warranty Terms and Conditions:
 - 3.2 The "Warranty Period" for the warranties in Clause 1 shall mean the respective number of years or for as long as the Covered Person commencing on the date of substantial completion named above shall live and own the property on which the material was originally installed.
 - 3.3 Registration of the product is required within ninety (90) days from substantial completion for the warranty to be in effect. This warranty is valid for the original owner and one other subsequent owner of the structure where the product(s) have been installed.
 - 3.4 Normal atmospheric conditions exclude corrosive or aggressive atmospheres such as those contaminated with chemical fumes or other corrosive elements. The product finish is not meant for marine use on boats, ships or offshore platforms.
 - 3.5 The product finish warranties as outlined in Clause 2 shall include coverage of the finish as it relates to the impact effects from hail and woodpecker birds.
 - 3.6 Under no circumstance shall Longboard's liability under this limited warranty exceed 2.5 times the total corresponding Longboard material cost (excluding sales tax, labor and installation related costs) as noted on the original purchase invoice and paid by the Buyer for the specific project.
- Clause 4**
- 4.1 This warranty will not extend or cover:
 - 4.2 Damages to the coated metal caused by handling, shipping, processing and/or installation; or
 - 4.3 Damages to the coated metal caused by scratching or abrading after installation; or
 - 4.4 Damages to the coated metal as a result of standing water in horizontal installations.
 - 4.5 The warranty will not be applicable to damage or failure, which is caused by acts of God, falling objects, external forces, explosions, fire, riots, civil commotion's, acts of war, or other such similar or dissimilar occurrences beyond The Company's control.
 - 4.6 Customer shall make available to The Company the dates of the installation of the coated metal, the maintenance records including details of washing and cleaning procedures in compliance with the cleaning requirements as stated in the Required Maintenance section of this warranty. Customers shall demonstrate that the failure of the coated metal was due to a breach of the warranty stated herein.
 - 4.7 Claims must be made in writing to Longboard within 30 days of the discovery of a problem and authorization obtained prior to beginning any repair and/or refinishing work.
- 4.8** The claimant must provide proof of coverage. Claims can be made by writing to Longboard at the Product Performance Department. After receiving such notice, The Company must be given a reasonable opportunity to inspect and verify the claim. Longboard exclusive liability under this warranty, or otherwise, will be limited to refinishing and/or repairing, at The Company's sole discretion, the defective powder coated product. The warranty on any refinished, repaired or replaced coated metal supplied hereunder shall be for the remainder of the warranty period applicable to the originally coated metal. All warranty work will be performed by a company or contractor selected by Longboard. Color variance between refinished and/or repainted product and original shall not be indicative of a defect.
- 4.9** This warranty represents the entire agreement between parties in relation to its subject matter and supersedes any previous agreement whether written or oral between the parties in relation to its subject matter. The limited warranties state the entire liability of Longboard with respect to the products covered by them. The Company shall have no liability for any incidental or consequential damages. No person is authorized to make any representation or warranty on behalf of Longboard except as expressly set forth above, and any such statement shall not be binding on The Company. Except as expressly set forth above, Longboard makes no warranty of any kind, express or implied, including, without limitation, any implied warranty of merchantability or fitness for a particular purpose. Warranties shall be the duration of the limited warranty, or such shorter duration as provided under applicable local law. These limited warranties give you specific legal rights, and you may also have other rights which vary from area to area.
- 4.10** Nothing in this warranty shall be construed as a warranty of the workmanship of any installer or as imposing on Longboard any liability for unsatisfactory performance caused by faulty workmanship in installation.
- 4.11** It's agreed all parties involved that all claims and disputes relating to this agreement that cannot be settled through negotiation will try in good faith to first settle the dispute by mediation administered by the American Arbitration Association (Construction Industry Mediation Procedures) as a prelude to mandatory binding arbitration. Such binding arbitration is to be conducted and administered by the Construction Industry Arbitration Rules of the American Arbitration Association. Both seller and purchaser agree to share equally in the costs of both mediation and arbitration and that such binding arbitration will be the sole and final remedial action.
- 4.12** Required Maintenance. Depending on the Project Environment, follow the maintenance schedule as outlined in the Longboard Care & Maintenance Guide. Use a soft sponge or cloth, water and mild detergent, non-abrasive soap with the pH range of 5-9 to clean the powder coated area of dirt, grime and other debris. Pressure washing and the use of harsh detergents or chemicals is not recommended. Include in your maintenance records the following: date, time, specific products used, name of maintenance person and their designation, maintenance company name and general condition of the powder coated finish.

I have read and agree to the terms of the Longboard® Product 15 year powder coated surface and 50 year aluminum extruded profile(s) warranty and acknowledge receipt of a copy of the Warranty Certificate.

Name of owner or contractor:

Date:

Signature:



Duly authorized on behalf of Longboard:

Name and designation:

Date:

Signature:

20 Year Non-Prorated Powder Coating Finish - 50 Year Non-Prorated Extruded Aluminum Profiles [Limited Warranty]
Warranty granted to (building owner):

Longboard Architectural Products Inc. ("Longboard," "The Company") products as identified by the Product Codes listed will conform to the standards set out in Clause 1 and Clause 2 of this Warranty, subject to the terms and conditions set out in Clause 3 and 4 of this Warranty.

Product codes: Product description:

Finish:	

Install contractor	
Project name	
Project address	
Address 2	Install start date
Date of substantial completion	

This Pinnacle Warranty is only valid for applications within Canada and USA. All applications outside of Canada and USA are required to contact Longboard for assistance.

- Clause 1**
Extruded Aluminum Profile(s) with Powder Coat Finish Longboard expressly warrants that its product line is free from manufacturing defects in material or workmanship.
- 1.1 When product is applied according to Longboard Instructions and properly maintained, such product is guaranteed against the following:
 - 1.2 Buckling: The product itself will be free of any buckling that is not associated with the substrate and/or structure to which the Longboard system is attached. For the purpose of this warranty, buckling shall be defined as warping of the product(s) exceeding one sixteenth of an inch out of plane per linear foot.
 - 1.3 Corrosion: When installed in normal atmospheric conditions according to Longboard Instructions and properly maintained, such product is further guaranteed against rusting and corroding. Subject to the limitations set out in Clause 3 and 4.
 - 1.4 What we will do: If, during the twenty (20) year Limited Warranty Period on the powder coating finish, the Product is defective in material or workmanship, Longboard will, in its sole discretion, either repair or replace the defective portion of the Product.
 - 1.5 What we will do: If, during the fifty (50) year Limited Warranty Period on the extruded aluminum profiles, the Product is defective in material or workmanship, Longboard will, in its sole discretion, either repair or replace the defective portion of the Product.
 - 1.6 After the 20th year, this Limited Warranty on the powder coated finish will expire and shall no longer be applicable.
 - 1.7 After the 50th year, this Limited Warranty on the aluminum extruded profile(s) will expire and shall no longer be applicable.
 - 1.8 Longboard replacement of the defective Product or reimbursement of this Limited Warranty is the exclusive remedy for the Covered Person for any defect in materials or workmanship. The Company will pay for all reasonable costs including material and labor as it relates to the repair and/or replacement of the defective Product.
- Clause 2**
Product Finish - AAMA 2605 Performance Specification
- 2.1 During the first twenty (20) years of this warranty:
 - 2.2 Checking/Cracking: No visible checking or cracking of the product finish on the building.
 - 2.3 Chalking Resistance: No chalking of the product finish on the building in excess of that represented by No.8 rating based on ASTM D4214.
 - 2.4 Color Retention: No color change of the product finish on the building greater than 5 (five) CIE Lab Δ E units calculated in accordance with ASTM 2244 Section 6.3. Color change shall be measured on the exposed paint surface which has been cleaned of oil, grease, chalk, oxidized film or other contaminants, corresponding values shall be measured on the control panel.
 - 2.5 Gloss Retention: Coated surface will exhibit gloss retention of a minimum of 50% of the original. Gloss retention shall be measured on the exposed paint surface which has been cleaned of oil, grease, chalk, oxidized film or other contaminants, corresponding values shall be measured on the control panel.
- Clause 3**
- 3.1 Warranty Terms and Conditions:
 - 3.2 The "Warranty Period" for the warranties in Clause 1 shall mean the respective number of years or for as long as the Covered Person commencing on the date of substantial completion named above shall live and own the property on which the material was originally installed.
 - 3.3 Registration of the product is required within ninety (90) days from substantial completion for the warranty to be in effect. This warranty is valid for the original owner and one other subsequent owner of the structure where the product(s) have been installed.
 - 3.4 Normal atmospheric conditions exclude corrosive or aggressive atmospheres such as those contaminated with chemical fumes or other corrosive elements. The product finish is not meant for marine use on boats, ships or offshore platforms.
 - 3.5 The product finish warranties as outlined in Clause 2 shall include coverage of the finish as it relates to the impact effects from hail and woodpecker birds.
 - 3.6 Under no circumstance shall Longboard's liability under this limited warranty exceed 2.5 times the total corresponding Longboard material cost (excluding sales tax, labor and installation related costs) as noted on the original purchase invoice and paid by the Buyer for the specific project.
- Clause 4**
- 4.1 This warranty will not extend or cover:
 - 4.2 Damages to the coated metal caused by handling, shipping, processing and/or installation; or
 - 4.3 Damages to the coated metal caused by scratching or abrading after installation; or
 - 4.4 Damages to the coated metal as a result of standing water in horizontal installations.
 - 4.5 The warranty will not be applicable to damage or failure, which is caused by acts of God, falling objects, external forces, explosions, fire, riots, civil commotion, acts of war, or other such similar or dissimilar occurrences beyond The Company's control.
 - 4.6 Customer shall make available to The Company the dates of the installation of the coated metal, the maintenance records including details of washing and cleaning procedures in compliance with the cleaning requirements as stated in the Required Maintenance section of this warranty. Customers shall demonstrate that the failure of the coated metal was due to a breach of the warranty stated herein.
 - 4.7 Claims must be made in writing to Longboard within 30 days of the discovery of a problem and authorization obtained prior to beginning any repair and/or refinishing work.
- 4.8** The claimant must provide proof of coverage. Claims can be made by writing to Longboard at the Product Performance Department. After receiving such notice, The Company must be given a reasonable opportunity to inspect and verify the claim. Longboard exclusive liability under this warranty, or otherwise, will be limited to refinishing and/or repairing, at The Company's sole discretion, the defective powder coated product. The warranty on any refinished, repaired or replaced coated metal supplied hereunder shall be for the remainder of the warranty period applicable to the originally coated metal. All warranty work will be performed by a company or contractor selected by Longboard. Color variance between refinished and/or repainted product and original shall not be indicative of a defect.
- 4.9** This warranty represents the entire agreement between parties in relation to its subject matter and supersedes any previous agreement whether written or oral between the parties in relation to its subject matter. The limited warranties state the entire liability of Longboard with respect to the products covered by them. The Company shall have no liability for any incidental or consequential damages. No person is authorized to make any representation or warranty on behalf of Longboard except as expressly set forth above, and any such statement shall not be binding on The Company. Except as expressly set forth above, Longboard makes no warranty of any kind, express or implied, including, without limitation, any implied warranty of merchantability or fitness for a particular purpose. Warranties shall be the duration of the limited warranty, or such shorter duration as provided under applicable local law. These limited warranties give you specific legal rights, and you may also have other rights which vary from area to area.
- 4.10** Nothing in this warranty shall be construed as a warranty of the workmanship of any installer or as imposing on Longboard any liability for unsatisfactory performance caused by faulty workmanship in installation.
- 4.11** It's agreed all parties involved that all claims and disputes relating to this agreement that cannot be settled through negotiation will try in good faith to first settle the dispute by mediation administered by the American Arbitration Association (Construction Industry Mediation Procedures) as a prelude to mandatory binding arbitration. Such binding arbitration is to be conducted and administered by the Construction Industry Arbitration Rules of the American Arbitration Association. Both seller and purchaser agree to share equally in the costs of both mediation and arbitration and that such binding arbitration will be the sole and final remedial action.
- 4.12** Required Maintenance. Depending on the Project Environment, follow the maintenance schedule as outlined in the Longboard Care & Maintenance Guide. Use a soft sponge or cloth, water and mild detergent, non-abrasive soap with the pH range of 5-9 to clean the powder coated area of dirt, grime and other debris. Pressure washing and the use of harsh detergents or chemicals is not recommended. Include in your maintenance records the following: date, time, specific products used, name of maintenance person and their designation, maintenance company name and general condition of the powder coated finish.

I have read and agree to the terms of the Longboard® Product 20 year powder coated surface and 50 year aluminum extruded profile(s) warranty and acknowledge receipt of a copy of the Warranty Certificate.

Name of owner or contractor:

Date:

Signature:

Duly authorized on behalf of Longboard:
Name and designation:

Date:

Signature: