

6" LAP PLANK TYPICAL DETAILS

TABLE OF CONTENT

(Click on the drawing name below to be directed to the right profile)

[MIDDLE OF WALL DETAIL – 6" LAP PLANK](#)

[BOTTOM OF WALL DETAIL – 6" LAP PLANK](#)

[COMPRESSION JOINT DETAIL – 6" LAP PLANK](#)

[PARAPET DETAIL – 6" LAP PLANK](#)

[OUTSIDE CORNER DETAIL – 6" LAP PLANK](#)

[INSIDE CORNER DETAIL – 6" LAP PLANK](#)

[WALL EDGE DETAIL – 6" LAP PLANK](#)

[TRADITIONAL FLAT REVEAL SET DETAIL – 6" LAP PLANK](#)

[NON 90 DEGREE CORNER DETAIL – 6" LAP PLANK](#)

[SINGLE BUTT-JOINT DETAIL - 6" LAP PLANK](#)

[MULTIPLE BUTT-JOINT DETAIL - 6" LAP PLANK](#)

[WINDOW DETAIL – 6" LAP PLANK](#)

[PENETRATION DETAIL – 6" LAP PLANK](#)

[LAP PLANK TO BOARD & BATTEN PLANK TRANSITION DETAIL – 6" LAP PLANK](#)

[LAP PLANK TO PARALLEL SOFFIT TRANSITION DETAIL - 6" LAP PLANK](#)

[LAP PLANK TO PERPENDICULAR SOFFIT TRANSITION DETAIL - 6" LAP PLANK](#)

[HARD FASTENING DETAIL - 6" LAP PLANK](#)

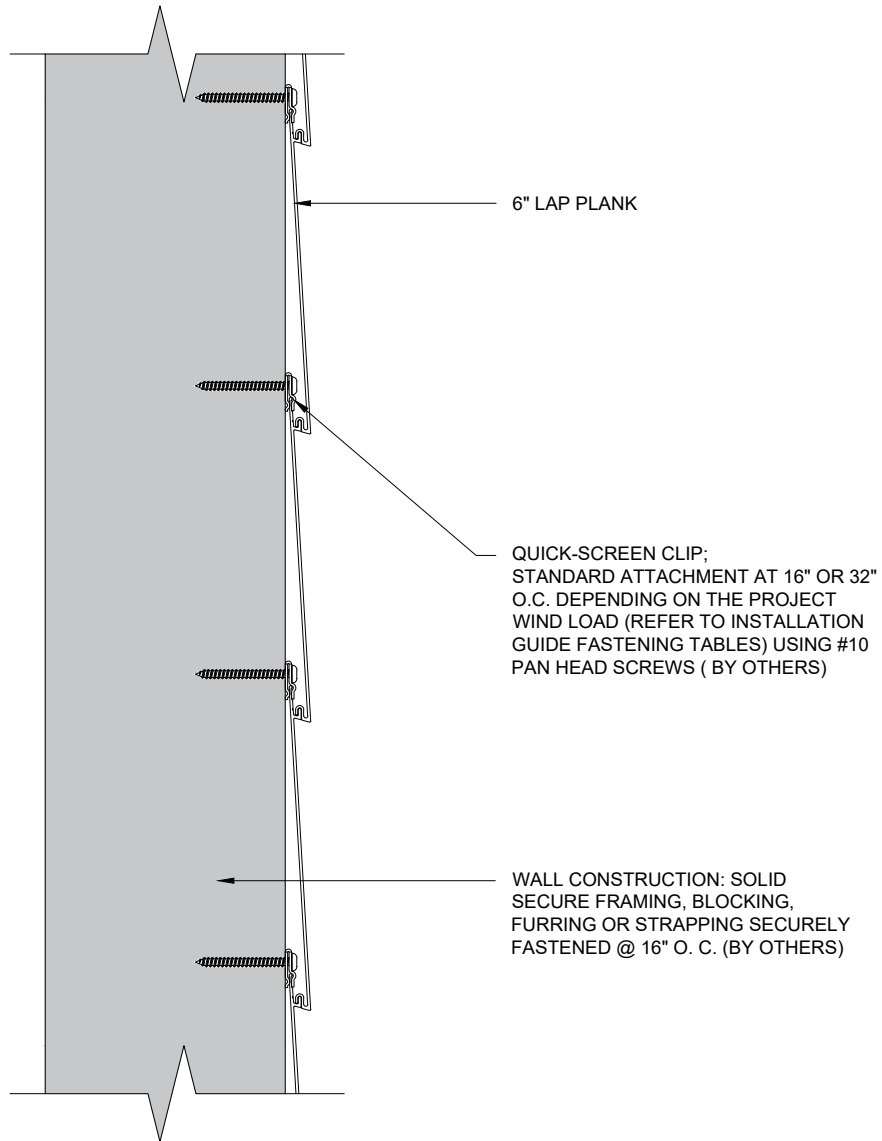

SECTION VIEW

MIDDLE OF WALL DETAIL
6" LAP PLANK

SCALE 1:4

These drawings are published as an information guide only. These CAD drawings are intended as templates to assist the designer, they do not contain the full detail required for construction and must be read in conjunction with the installation instructions on www.longboardproducts.com. You should obtain architectural, engineering or other technical advice to assess the suitability of these drawings to the requirements of your particular project. Longboard Architectural Products accepts no liability in respect to the use of these drawings. For complete installation instructions refer to the appropriate documentation here www.longboardproducts.com/resources/technical-documentation/installation-guides



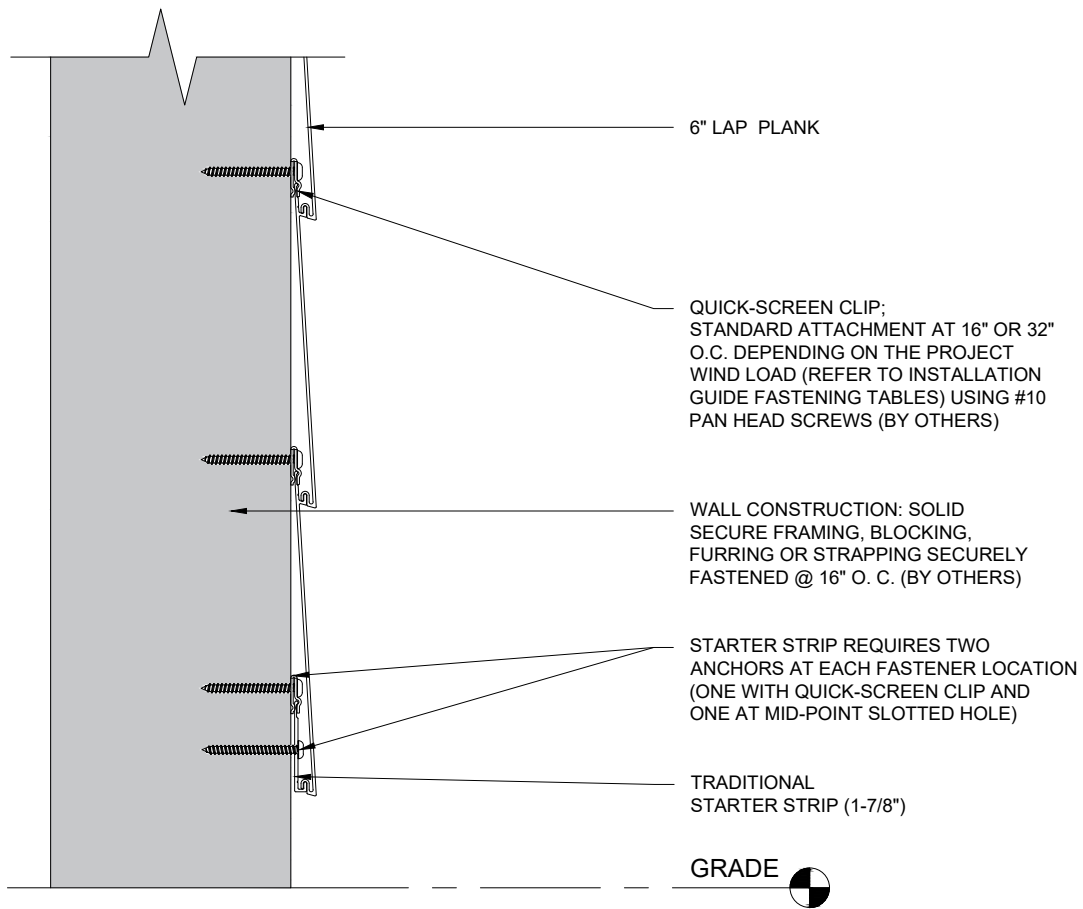

SECTION VIEW

These drawings are published as an information guide only. These CAD drawings are intended as templates to assist the designer, they do not contain the full detail required for construction and must be read in conjunction with the installation instructions on www.longboardproducts.com. You should obtain architectural, engineering or other technical advice to assess the suitability of these drawings to the requirements of your particular project. Longboard Architectural Products accepts no liability in respect to the use of these drawings. For complete installation instructions refer to the appropriate documentation here www.longboardproducts.com/resources/technical-documentation/installation-guides

BOTTOM OF WALL DETAIL 6" LAP PLANK

SCALE 1:4



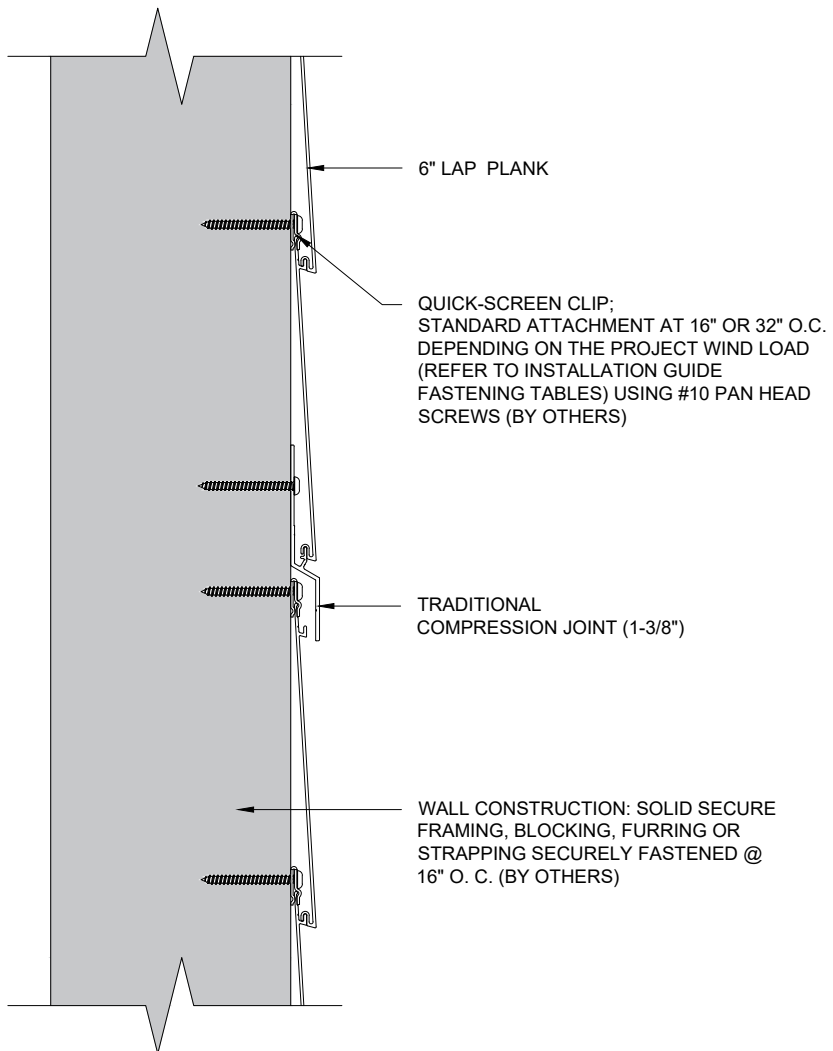

SECTION VIEW

COMPRESSION JOINT DETAIL
6" LAP PLANK

SCALE 1:4

These drawings are published as an information guide only. These CAD drawings are intended as templates to assist the designer, they do not contain the full detail required for construction and must be read in conjunction with the installation instructions on www.longboardproducts.com. You should obtain architectural, engineering or other technical advice to assess the suitability of these drawings to the requirements of your particular project. Longboard Architectural Products accepts no liability in respect to the use of these drawings. For complete installation instructions refer to the appropriate documentation here www.longboardproducts.com/resources/technical-documentation/installation-guides



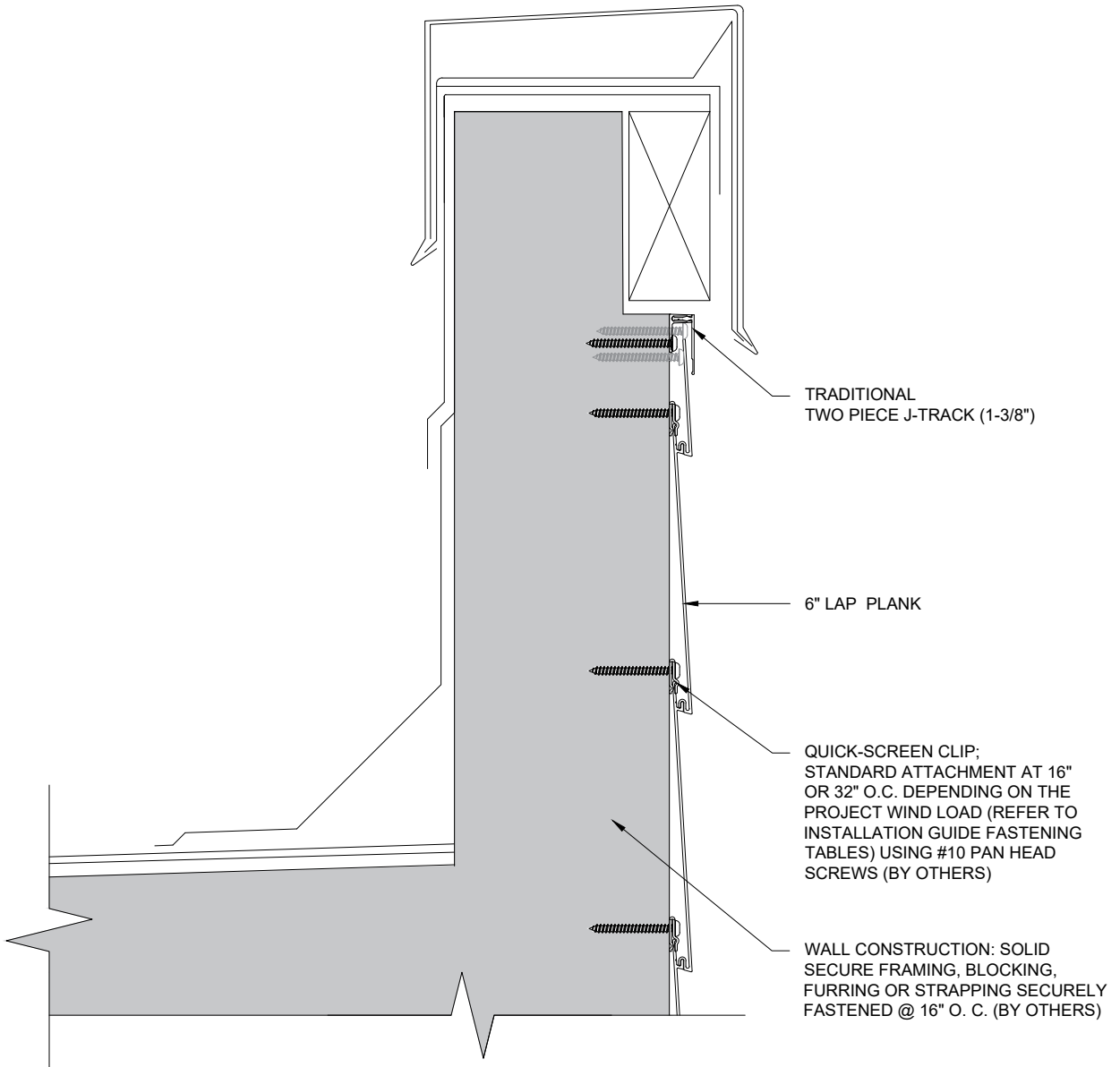

SECTION VIEW

PARAPET DETAIL
6" LAP PLANK

SCALE 1:4

These drawings are published as an information guide only. These CAD drawings are intended as templates to assist the designer, they do not contain the full detail required for construction and must be read in conjunction with the installation instructions on www.longboardproducts.com. You should obtain architectural, engineering or other technical advice to assess the suitability of these drawings to the requirements of your particular project. Longboard Architectural Products accepts no liability in respect to the use of these drawings. For complete installation instructions refer to the appropriate documentation here www.longboardproducts.com/resources/technical-documentation/installation-guides



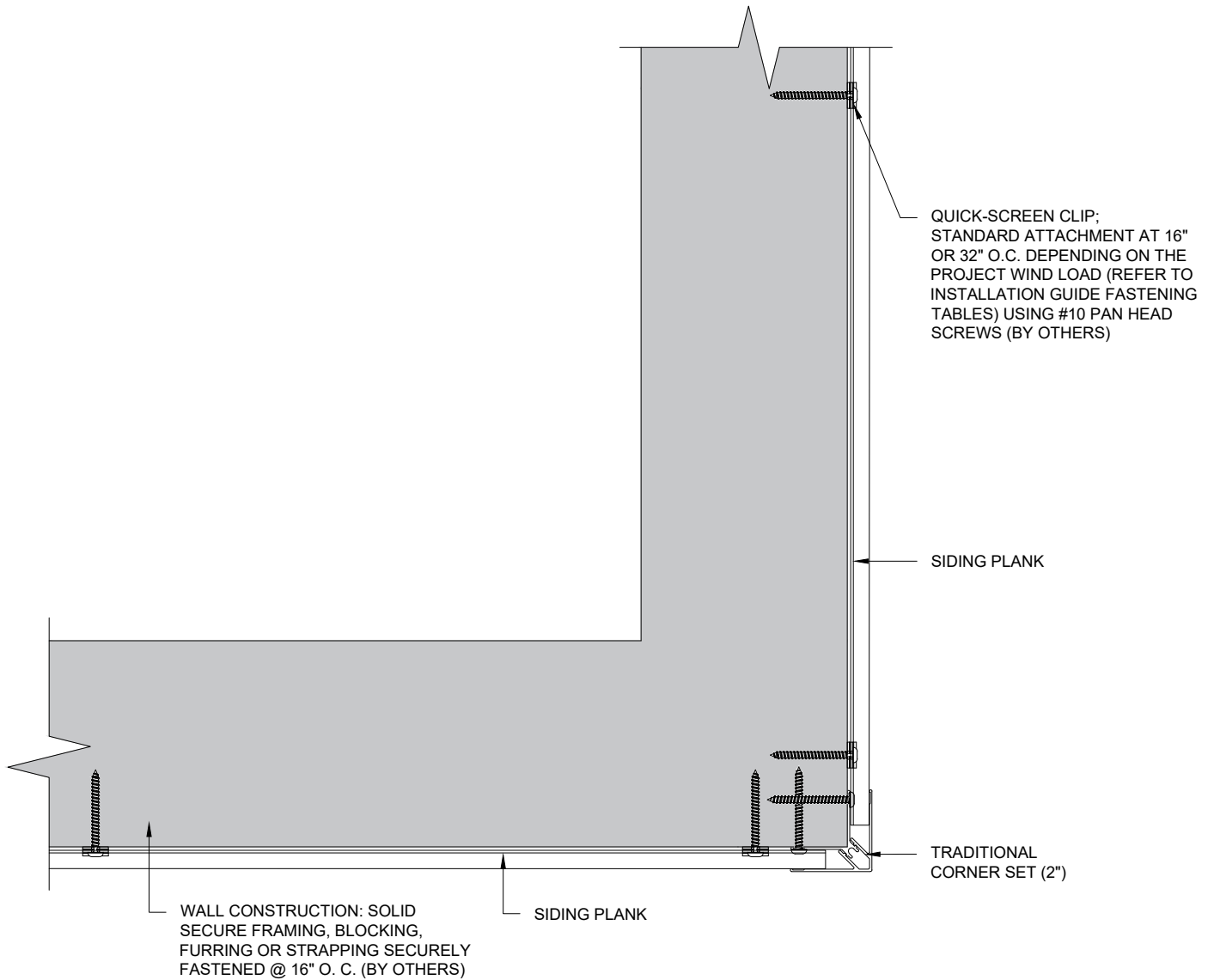

PLAN VIEW

OUTSIDE CORNER DETAIL
6" LAP PLANK

SCALE 1:4

These drawings are published as an information guide only. These CAD drawings are intended as templates to assist the designer, they do not contain the full detail required for construction and must be read in conjunction with the installation instructions on www.longboardproducts.com. You should obtain architectural, engineering or other technical advice to assess the suitability of these drawings to the requirements of your particular project. Longboard Architectural Products accepts no liability in respect to the use of these drawings. For complete installation instructions refer to the appropriate documentation here www.longboardproducts.com/resources/technical-documentation/installation-guides



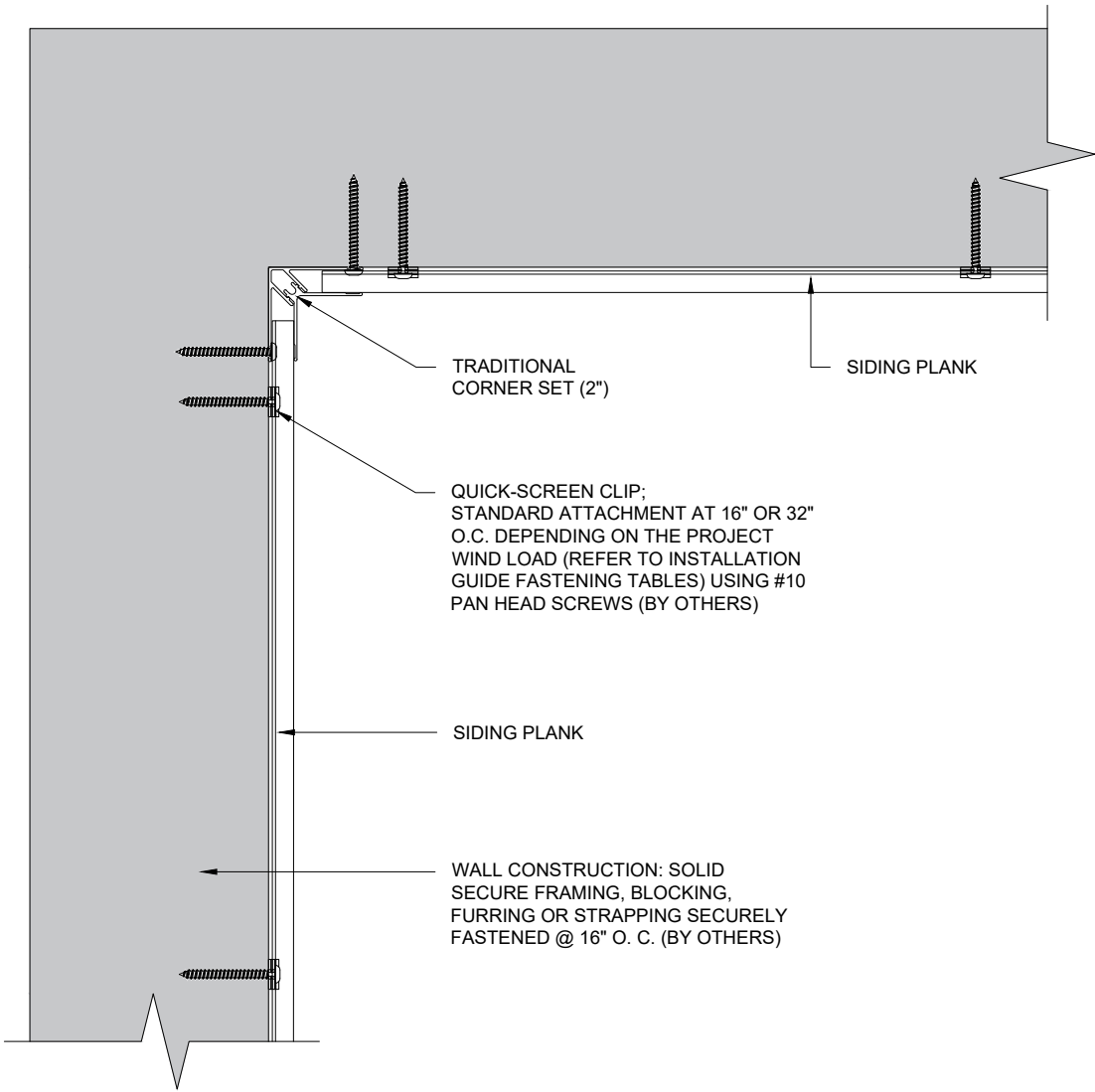

PLAN VIEW

These drawings are published as an information guide only. These CAD drawings are intended as templates to assist the designer, they do not contain the full detail required for construction and must be read in conjunction with the installation instructions on www.longboardproducts.com. You should obtain architectural, engineering or other technical advice to assess the suitability of these drawings to the requirements of your particular project. Longboard Architectural Products accepts no liability in respect to the use of these drawings. For complete installation instructions refer to the appropriate documentation here www.longboardproducts.com/resources/technical-documentation/installation-guides

INSIDE CORNER DETAIL 6" LAP PLANK

SCALE 1:4



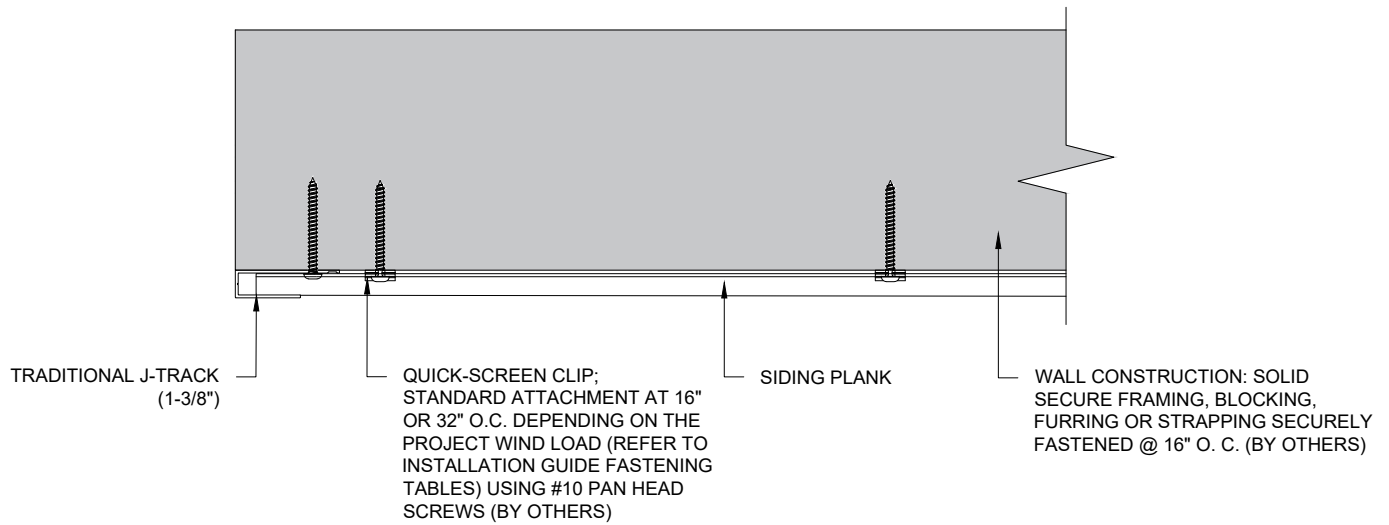

PLAN VIEW

These drawings are published as an information guide only. These CAD drawings are intended as templates to assist the designer, they do not contain the full detail required for construction and must be read in conjunction with the installation instructions on www.longboardproducts.com. You should obtain architectural, engineering or other technical advice to assess the suitability of these drawings to the requirements of your particular project. Longboard Architectural Products accepts no liability in respect to the use of these drawings. For complete installation instructions refer to the appropriate documentation here www.longboardproducts.com/resources/technical-documentation/installation-guides

WALL EDGE DETAIL 6" LAP PLANK

SCALE 1:4



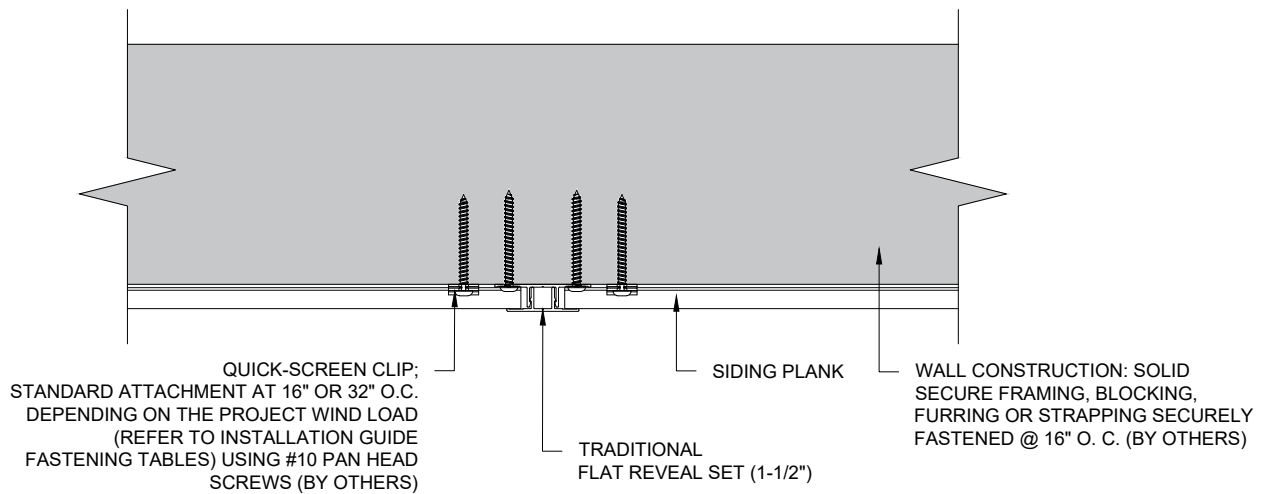

PLAN VIEW

These drawings are published as an information guide only. These CAD drawings are intended as templates to assist the designer, they do not contain the full detail required for construction and must be read in conjunction with the installation instructions on www.longboardproducts.com. You should obtain architectural, engineering or other technical advice to assess the suitability of these drawings to the requirements of your particular project. Longboard Architectural Products accepts no liability in respect to the use of these drawings. For complete installation instructions refer to the appropriate documentation here www.longboardproducts.com/resources/technical-documentation/installation-guides

TRADITIONAL FLAT REVEAL SET DETAIL 6" LAP PLANK

SCALE 1:4



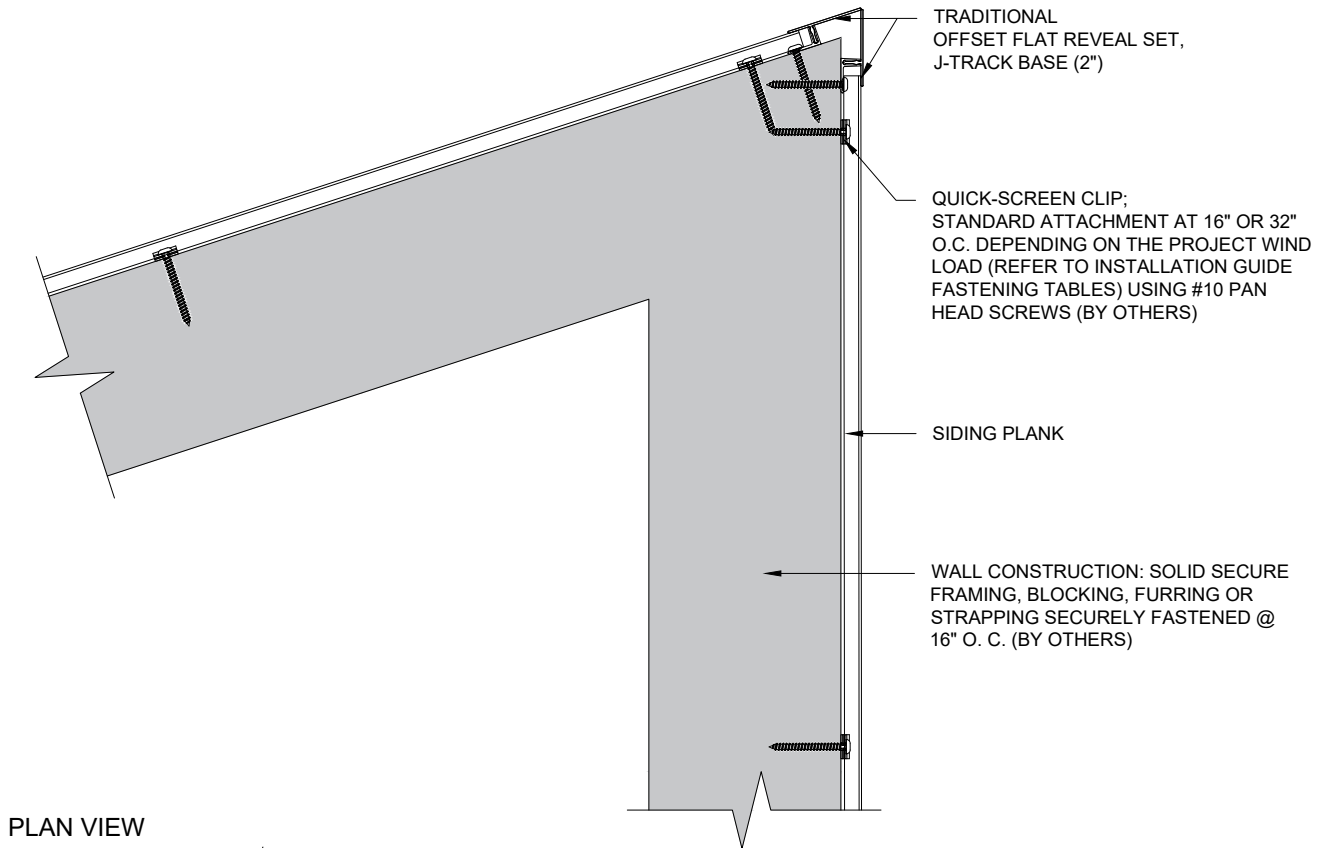

PLAN VIEW

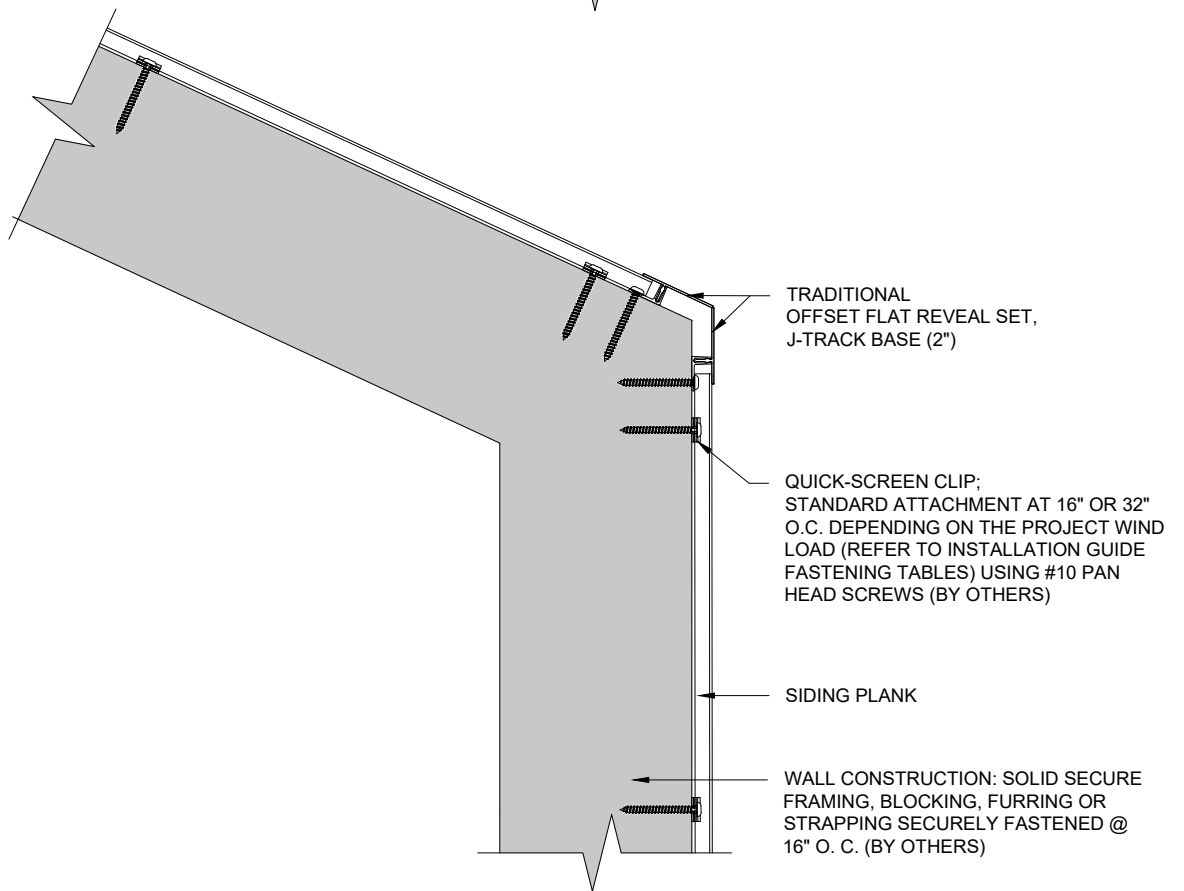

PLAN VIEW

These drawings are published as an information guide only. These CAD drawings are intended as templates to assist the designer, they do not contain the full detail required for construction and must be read in conjunction with the installation instructions on www.longboardproducts.com. You should obtain architectural, engineering or other technical advice to assess the suitability of these drawings to the requirements of your particular project. Longboard Architectural Products accepts no liability in respect to the use of these drawings. For complete installation instructions refer to the appropriate documentation here www.longboardproducts.com/resources/technical-documentation/installation-guides

NON 90 DEGREE CORNER DETAIL 6" LAP PLANK

SCALE 1:5



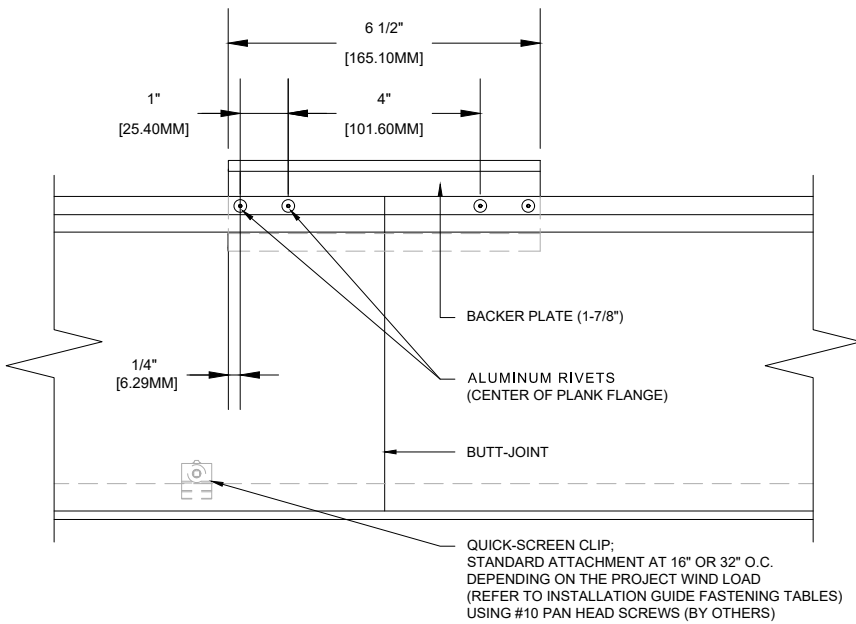

2 BUTT-JOINT KIT ENLARGED DETAIL
SCALE 1:4

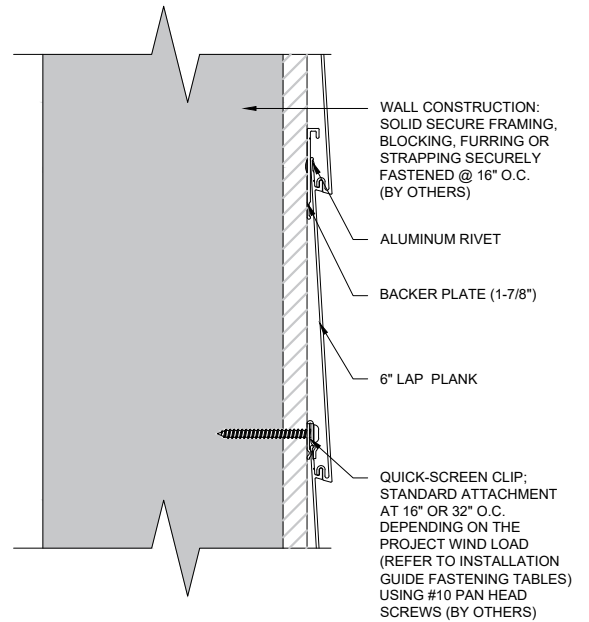

3 SECTION
SCALE 1:4

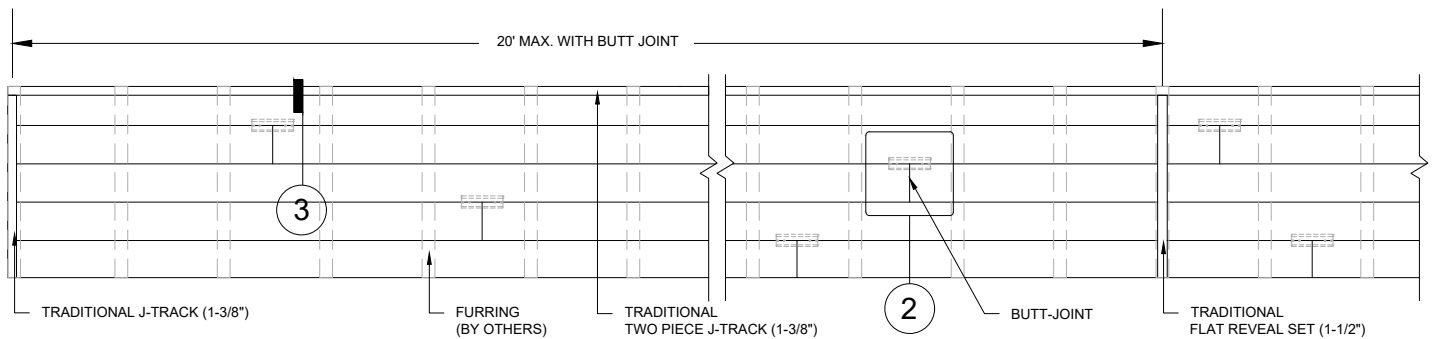

1 ELEVATION WITH SINGLE BUTT-JOINTS
SCALE 1:30

These drawings are published as an information guide only. These CAD drawings are intended as templates to assist the designer, they do not contain the full detail required for construction and must be read in conjunction with the installation instructions on www.longboardproducts.com. You should obtain architectural, engineering or other technical advice to assess the suitability of these drawings to the requirements of your particular project. Longboard Architectural Products accepts no liability in respect to the use of these drawings. For complete installation instructions refer to the appropriate documentation here www.longboardproducts.com/resources/technical-documentation/installation-guides

SINGLE BUTT-JOINT DETAIL 6" LAP PLANK

SCALE: AS INDICATED



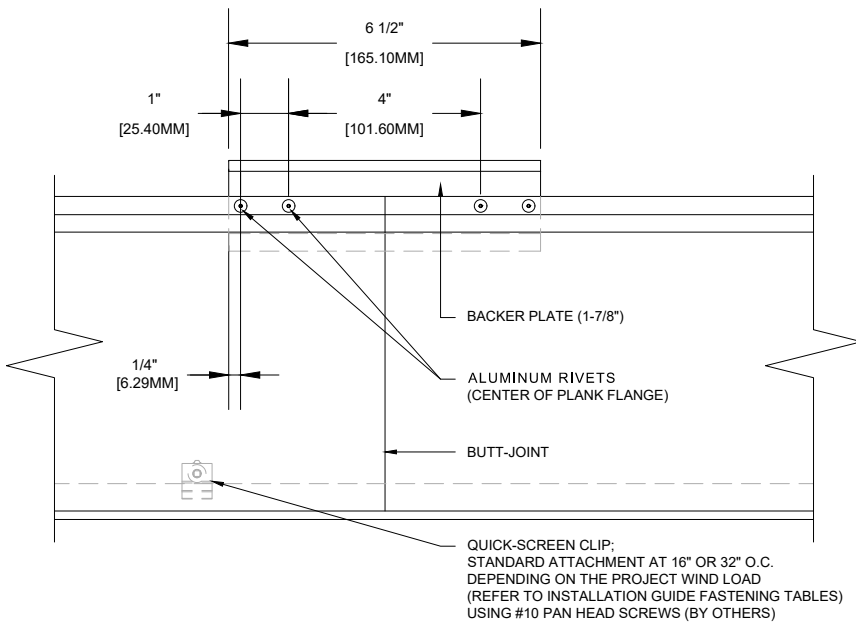

2 BUTT-JOINT KIT ENLARGED DETAIL
SCALE 1:4

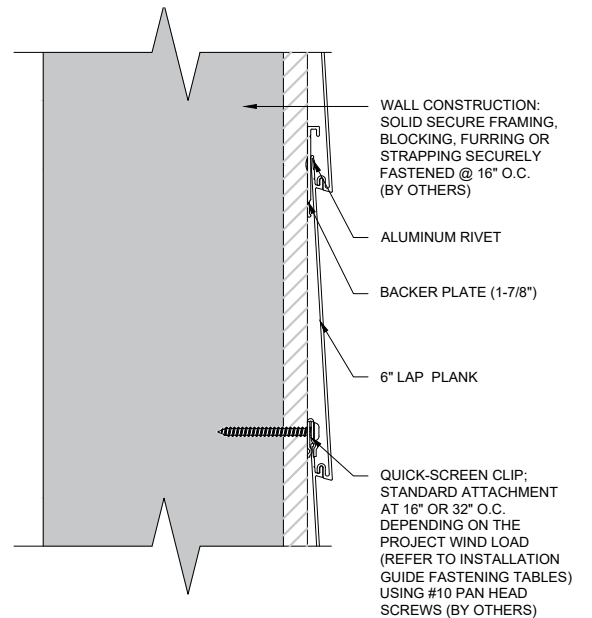

3 SECTION
SCALE 1:4

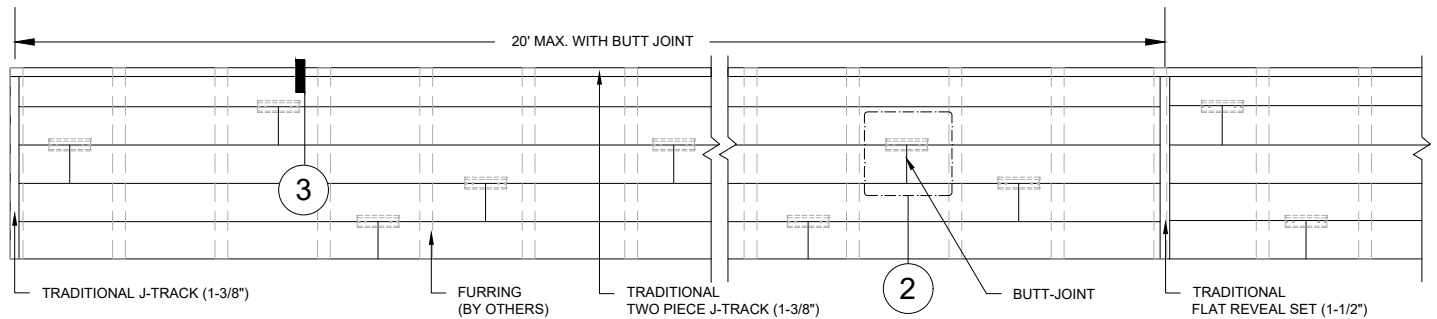

1 ELEVATION WITH MULTIPLE BUTT-JOINTS
SCALE 1:30

These drawings are published as an information guide only. These CAD drawings are intended as templates to assist the designer, they do not contain the full detail required for construction and must be read in conjunction with the installation instructions on www.longboardproducts.com. You should obtain architectural, engineering or other technical advice to assess the suitability of these drawings to the requirements of your particular project. Longboard Architectural Products accepts no liability in respect to the use of these drawings. For complete installation instructions refer to the appropriate documentation here www.longboardproducts.com/resources/technical-documentation/installation-guides

MULTIPLE BUTT-JOINT DETAIL 6" LAP PLANK

SCALE: AS INDICATED



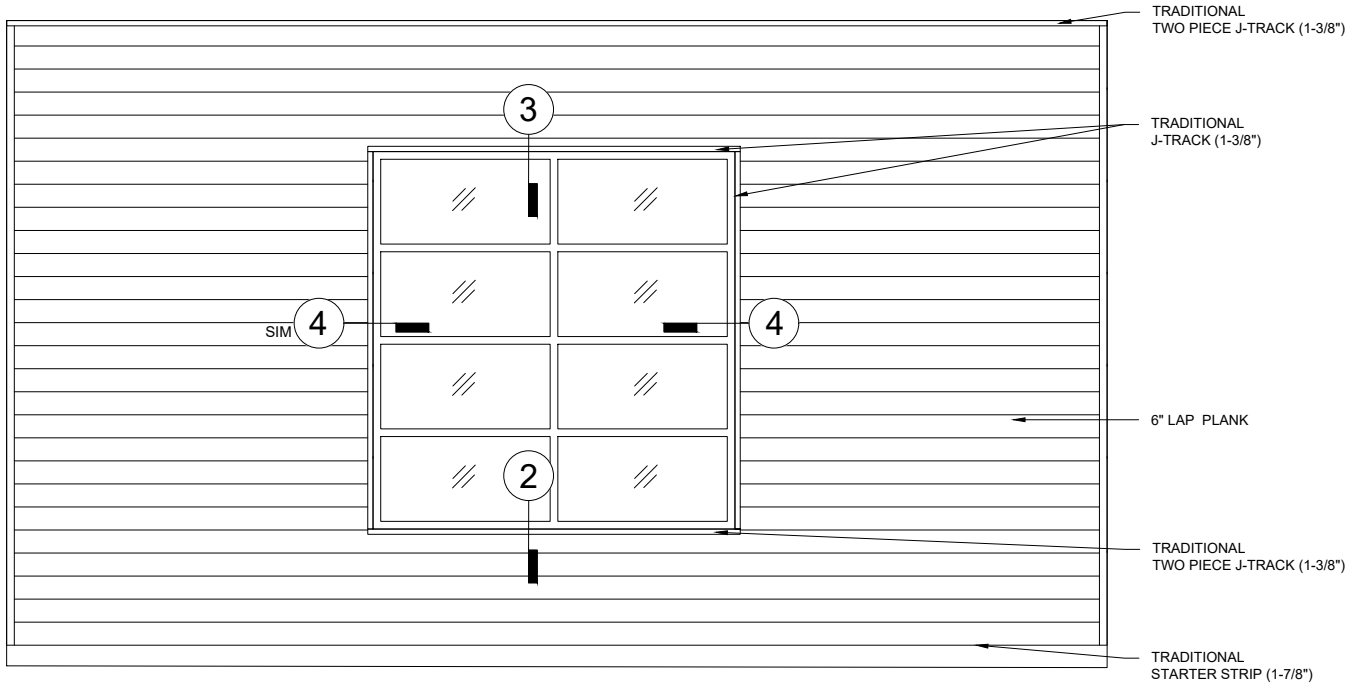

1 WALL ELEVATION
SCALE: 1:50

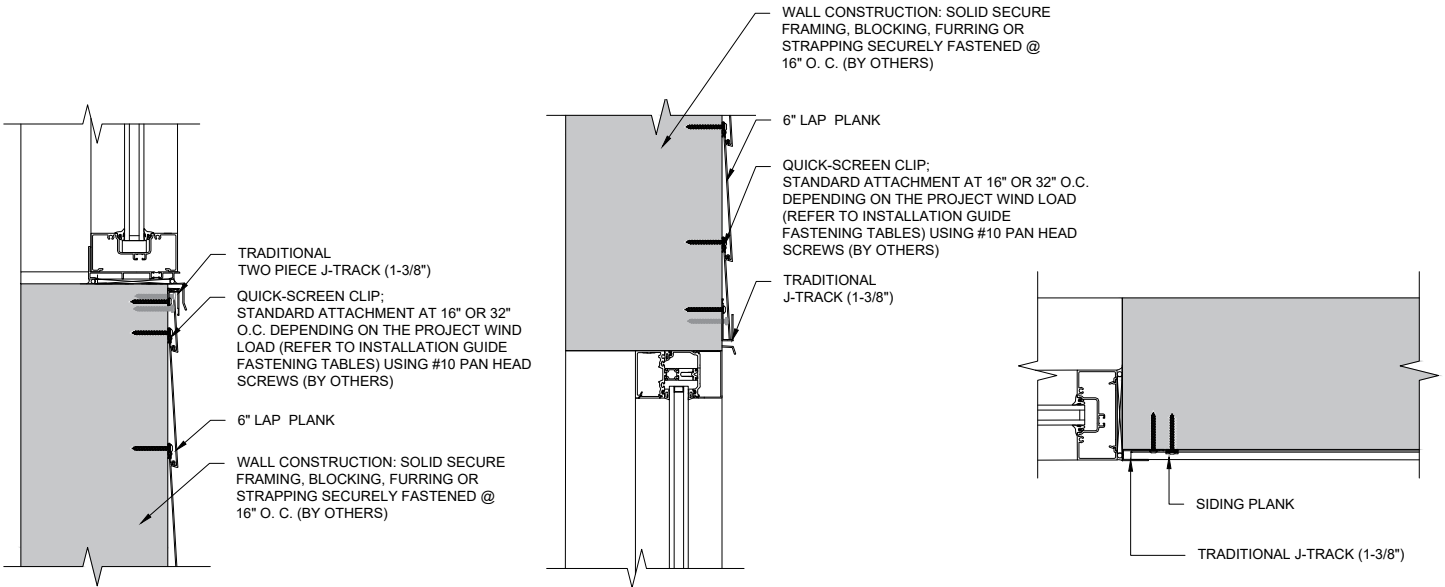

These drawings are published as an information guide only. These CAD drawings are intended as templates to assist the designer, they do not contain the full detail required for construction and must be read in conjunction with the installation instructions on www.longboardproducts.com. You should obtain architectural, engineering or other technical advice to assess the suitability of these drawings to the requirements of your particular project. Longboard Architectural Products accepts no liability in respect to the use of these drawings. For complete installation instructions refer to the appropriate documentation here www.longboardproducts.com/resources/technical-documentation/installation-guides

WINDOW DETAIL
6" LAP PLANK

SCALE: AS INDICATED



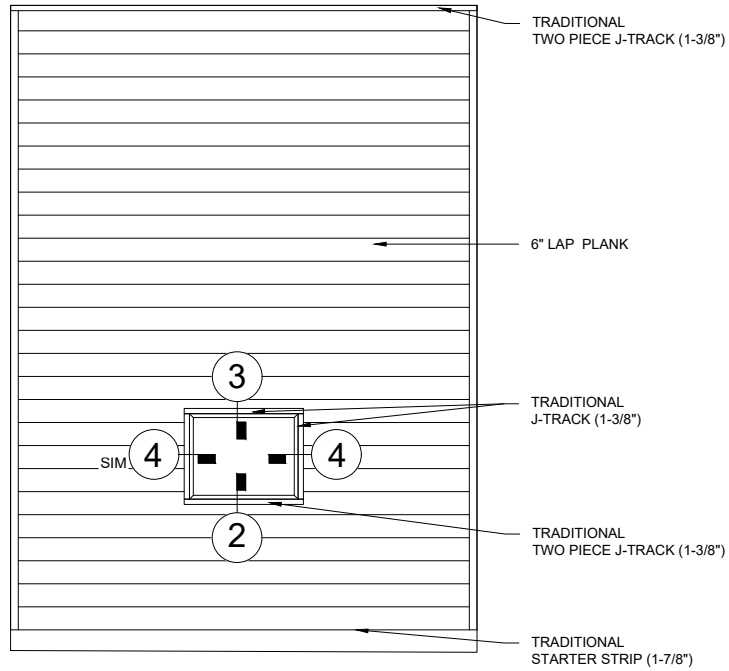

1 WALL ELEVATION
SCALE: 1:50

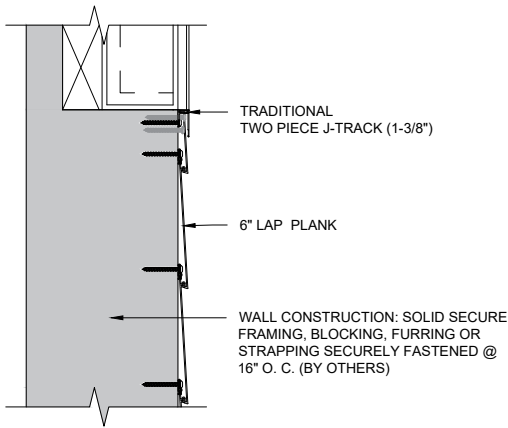

2 SILL DETAIL
SCALE: 1:10

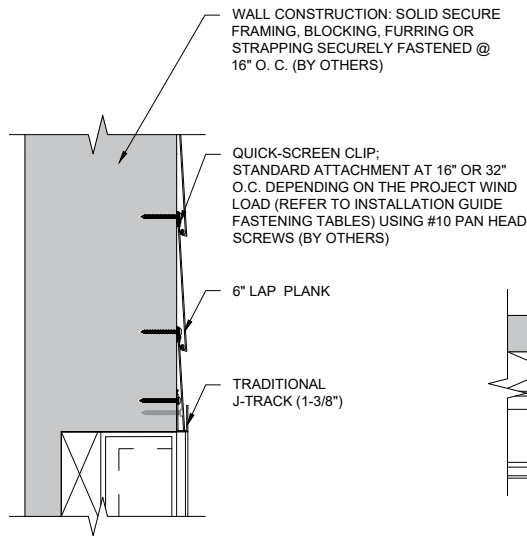

3 HEAD DETAIL
SCALE: 1:10

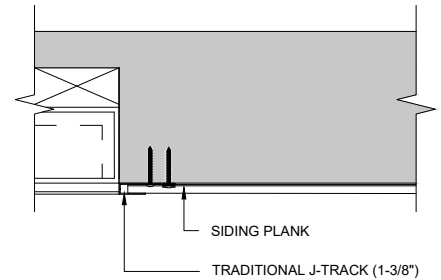

4 JAMB DETAIL
SCALE: 1:10

These drawings are published as an information guide only. These CAD drawings are intended as templates to assist the designer, they do not contain the full detail required for construction and must be read in conjunction with the installation instructions on www.longboardproducts.com. You should obtain architectural, engineering or other technical advice to assess the suitability of these drawings to the requirements of your particular project. Longboard Architectural Products accepts no liability in respect to the use of these drawings. For complete installation instructions refer to the appropriate documentation here www.longboardproducts.com/resources/technical-documentation/installation-guides

PENETRATION DETAIL 6" LAP PLANK

SCALE: AS INDICATED



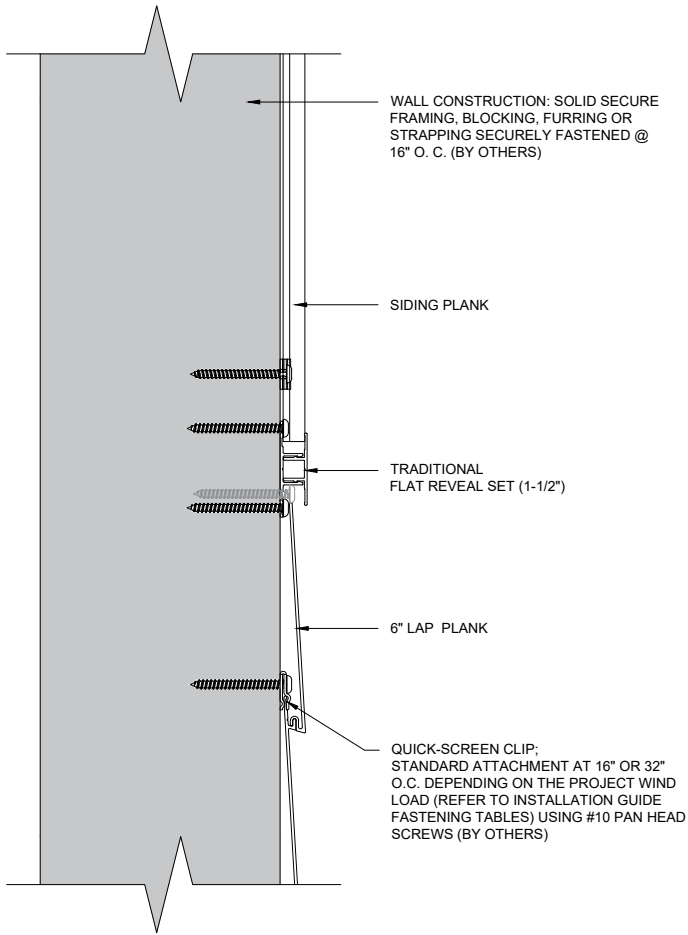

SECTION VIEW

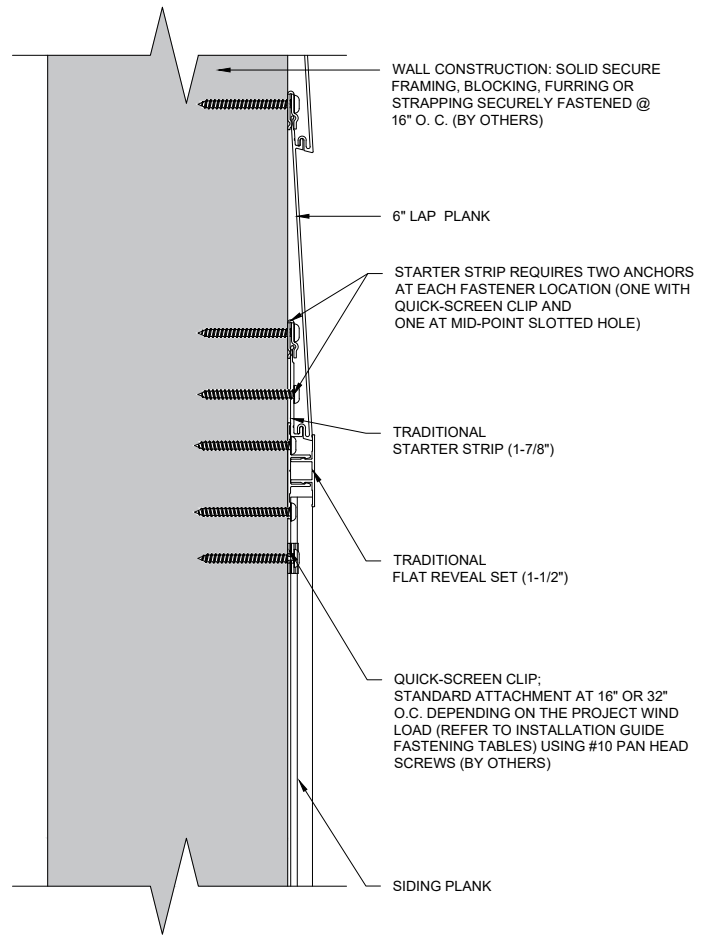

SECTION VIEW

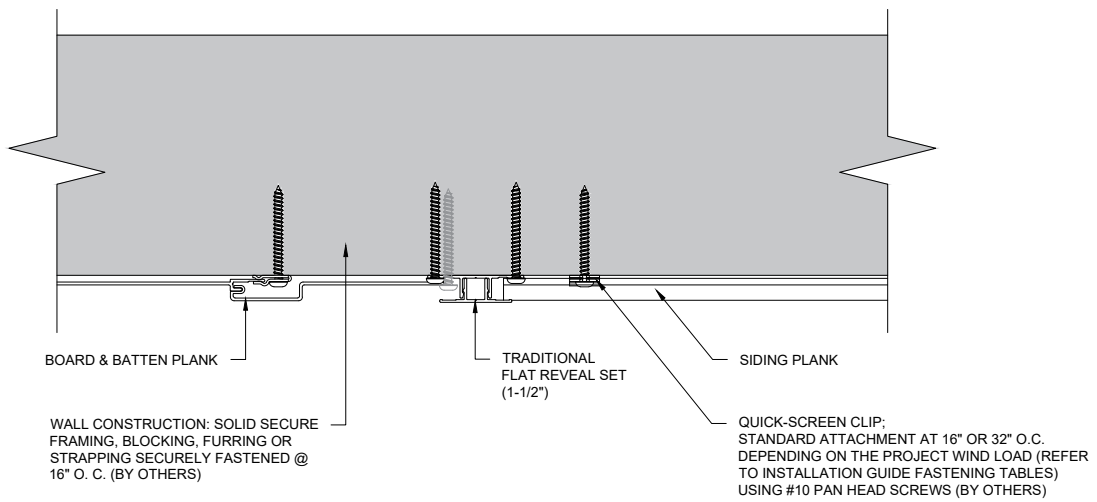

PLAN VIEW

These drawings are published as an information guide only. These CAD drawings are intended as templates to assist the designer, they do not contain the full detail required for construction and must be read in conjunction with the installation instructions on www.longboardproducts.com. You should obtain architectural, engineering or other technical advice to assess the suitability of these drawings to the requirements of your particular project. Longboard Architectural Products accepts no liability in respect to the use of these drawings. For complete installation instructions refer to the appropriate documentation here www.longboardproducts.com/resources/technical-documentation/installation-guides

LAP PLANK TO BOARD & BATTEN PLANK TRANSITION DETAIL

SCALE 1:4



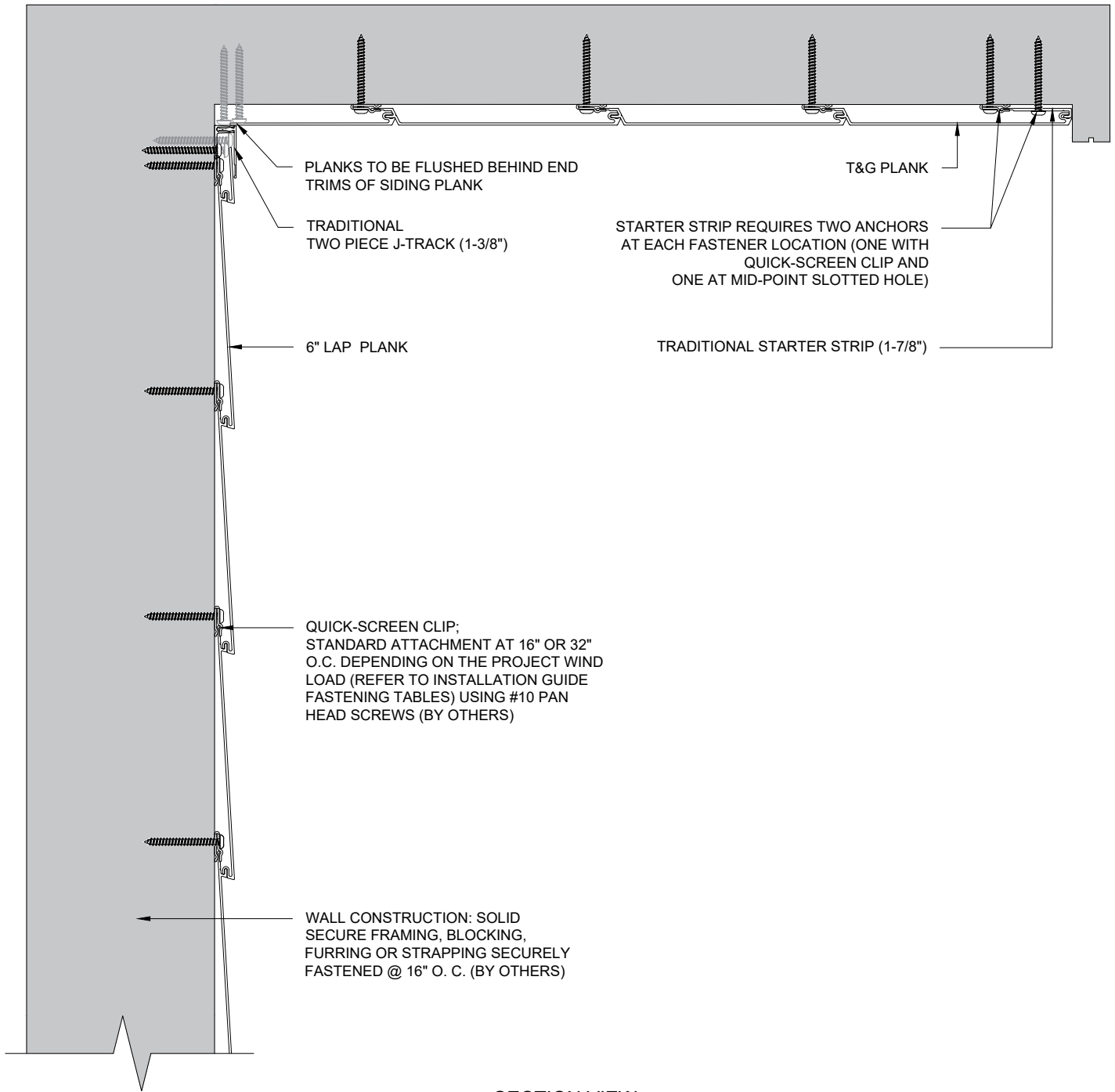

SECTION VIEW

6" LAP PLANK TO PARALLEL SOFFIT TRANSITION DETAIL

SCALE 1:4

These drawings are published as an information guide only. These CAD drawings are intended as templates to assist the designer, they do not contain the full detail required for construction and must be read in conjunction with the installation instructions on www.longboardproducts.com. You should obtain architectural, engineering or other technical advice to assess the suitability of these drawings to the requirements of your particular project. Longboard Architectural Products accepts no liability in respect to the use of these drawings. For complete installation instructions refer to the appropriate documentation here www.longboardproducts.com/resources/technical-documentation/installation-guides



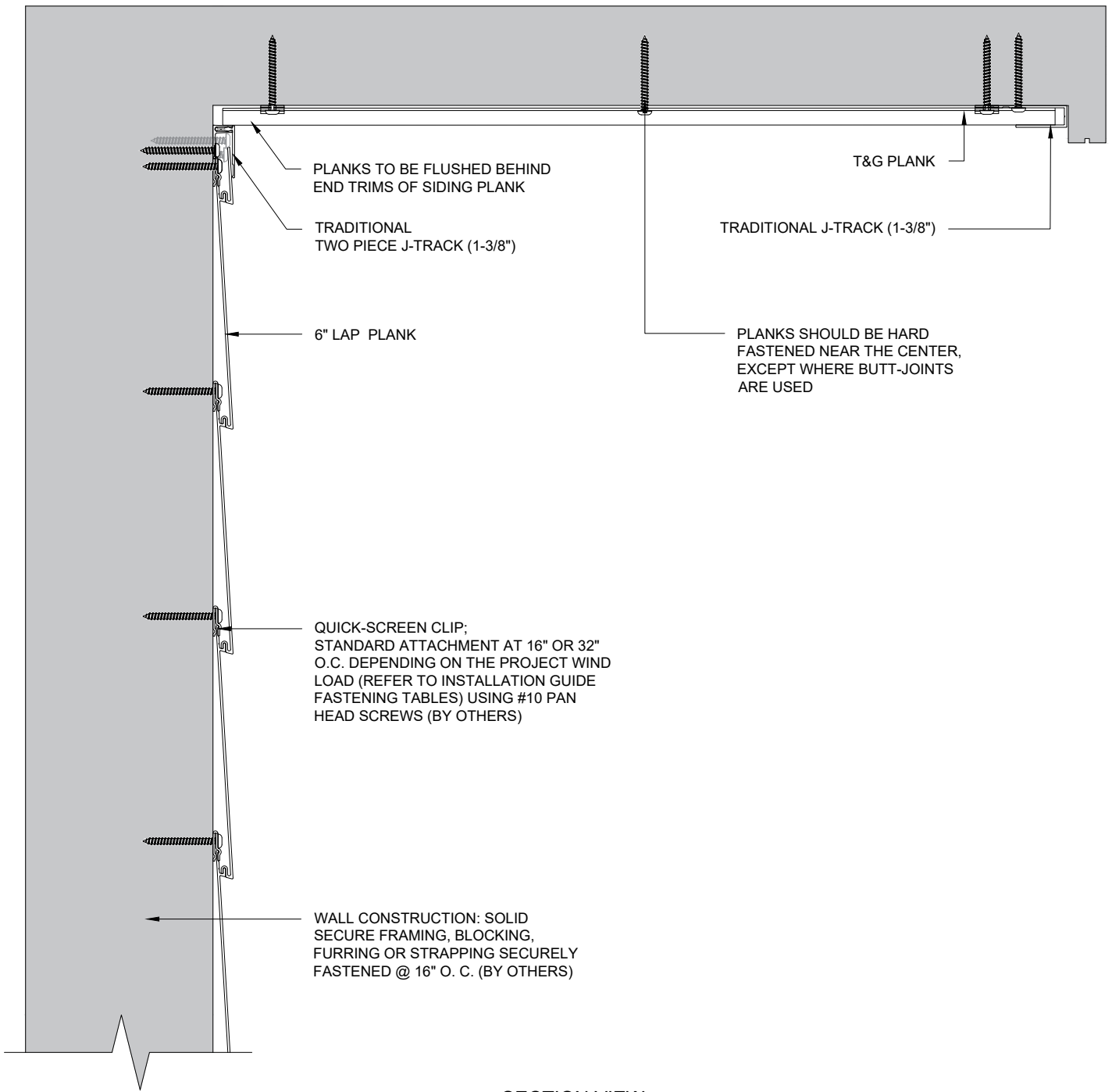

These drawings are published as an information guide only. These CAD drawings are intended as templates to assist the designer, they do not contain the full detail required for construction and must be read in conjunction with the installation instructions on www.longboardproducts.com. You should obtain architectural, engineering or other technical advice to assess the suitability of these drawings to the requirements of your particular project. Longboard Architectural Products accepts no liability in respect to the use of these drawings. For complete installation instructions refer to the appropriate documentation here www.longboardproducts.com/resources/technical-documentation/installation-guides

6" LAP PLANK TO PERPENDICULAR SOFFIT TRANSITION DETAIL

SCALE 1:4



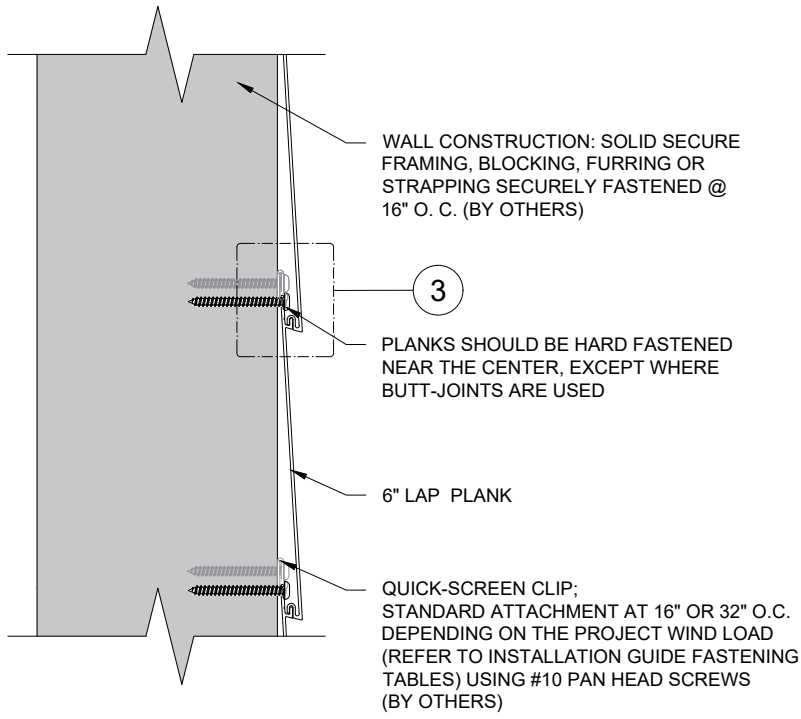

2 SECTION
SCALE 1:4

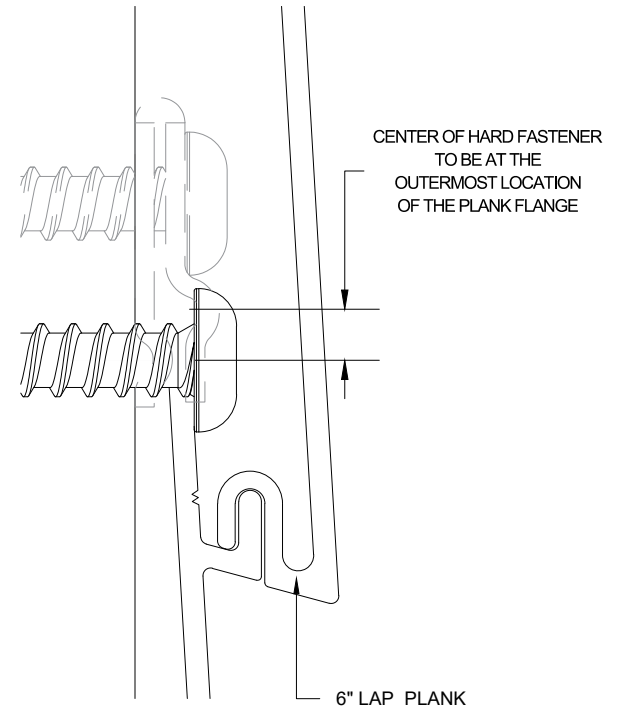

3 ENLARGED DETAIL
SCALE 2:1

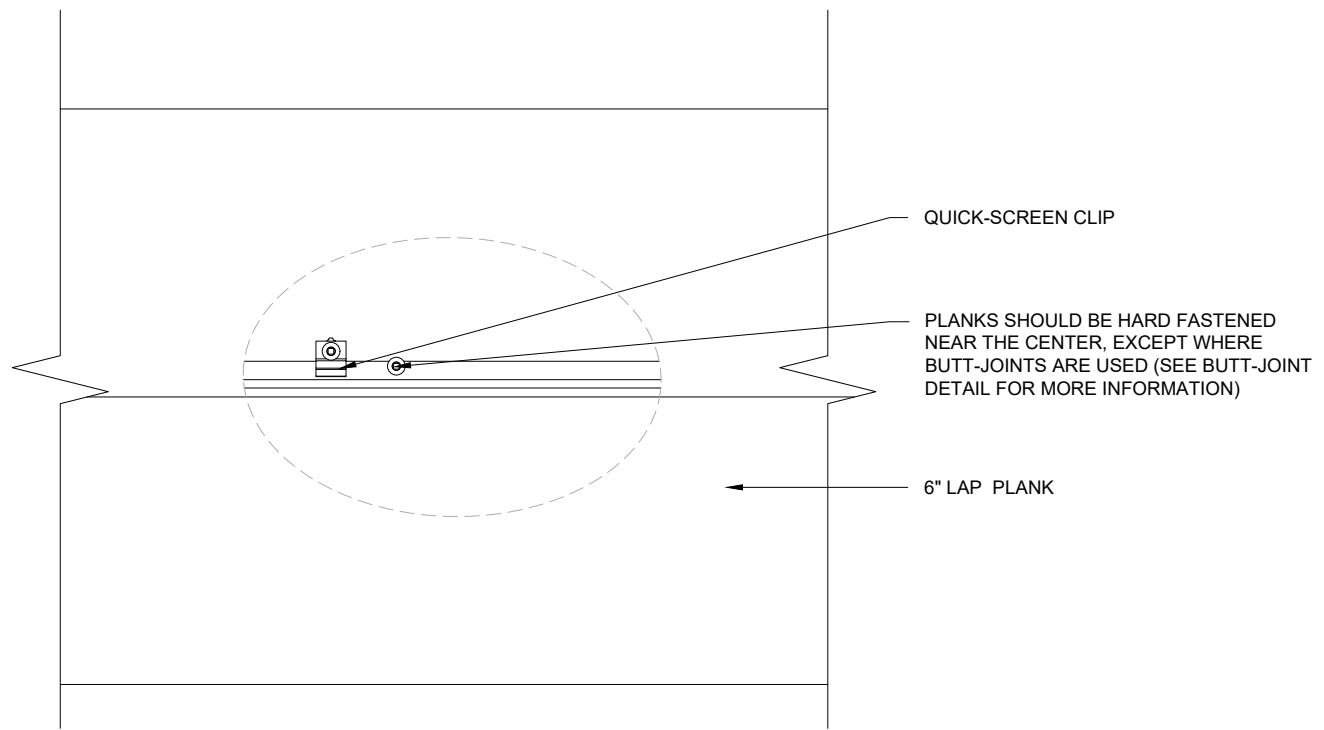

1 ELEVATION
SCALE 1:4

These drawings are published as an information guide only. These CAD drawings are intended as templates to assist the designer, they do not contain the full detail required for construction and must be read in conjunction with the installation instructions on www.longboardproducts.com. You should obtain architectural, engineering or other technical advice to assess the suitability of these drawings to the requirements of your particular project. Longboard Architectural Products accepts no liability in respect to the use of these drawings. For complete installation instructions refer to the appropriate documentation here www.longboardproducts.com/resources/technical-documentation/installation-guides

HARD FASTENING DETAIL
6" LAP PLANK
SCALE: AS INDICATED

