

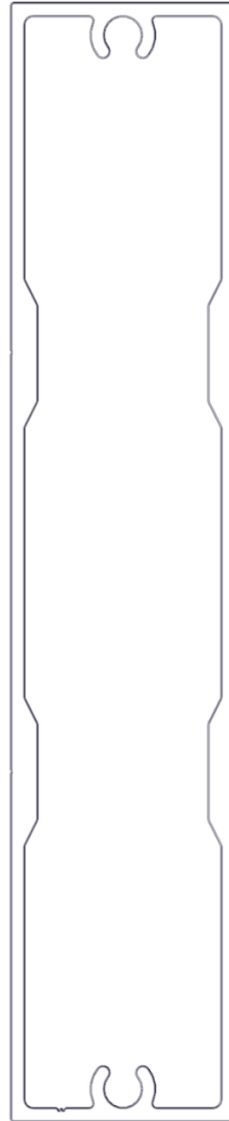

**LONGBOARD®**  
INSPIRING ARCHITECTURE

# Privacy Beam Soffit

Installation Guidelines

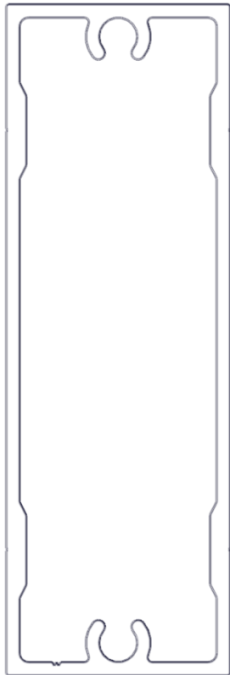

## Table of Contents

<b>Material Specifications</b>	<b>3</b>
Finishes	3
Expansion and contraction	3
Material ordering and deliveries	3
Storage and handling	3
Cleaning	3
Warranty	3
Graffiti Cleaning	4
<b>Components</b>	<b>5</b>
Components (Typical)	5
<b>Tools/Cutting/Fastening</b>	<b>6</b>
Tools	6
Cutting	6
Fastening/Fastener types	7
Framing requirements	7
<b>System Install</b>	<b>8</b>
Perimeter and field area limitations	8
Component assembly overview	9
Floating system	9
End Frame system	10
Preparation drilling for install	11
Install steps	12
Floating system	12
End Frame system	13
Details	14
Butt-Joints	14
<b>Appendix</b>	<b>15</b>
Tables 1 & 2 - Expansion & contraction	15
Table 3 – Allowable attachment span	16
Handling and care of products	17
Contact Info	18

## Material Specifications

### Finishes

- Longboard Products are available in a wide range of powder coated finishes
- Custom solid colors are available upon request
- Longboard Products are not recommended for use on marine applications in direct contact with salt water

Longboard extruded products are produced 1" (25mm) oversized, as one end is drilled for the coating process, and both ends have 1/2" (12mm) of masking tape (woodgrains only) which must be cut off for best results. Longboard Cladding is to be installed outboard of a weather resistant barrier, including all flashings, following code, and building requirements.

### Expansion & Contraction

Privacy Beam components expand & contract 1/4" (6mm) over 24' (7.3m) along the length, measured over a 30°C (54°F) temperature range. Due to this range of movement, Privacy Beam Fins /Battens should be installed with staggered butt-joints, leaving a 1/4" (6mm) min. gap, every 24' (7.3m) min.

See **Appendix for Tables 1 & 2, expansion/contraction calculations per foot/meter of material.**

### Material Ordering & Delivery

- 
- **Packaging:** Privacy Beams are sold in 24' lengths, 1x3 & 1x5.  
End caps are sold by the box: 20 caps/bx  
Single Posts are sold in 24' lengths
- 
- **Shipping:** Most Popular Finishes -ready to ship within 1 week  
Additional Finishes -ready to ship within 14 weeks  
Delivered on 24' (7.3m) long skids weighing up to 2000 lbs. A mechanical lift with forks is required on site to receive the order.
- 
- **QC:** Always inspect the delivery for damage and contact LB ASAP if there are any issues: [info@longboardproducts.com](mailto:info@longboardproducts.com) or 1-800-604-0343 and include your PO# and any pictures if possible. Mark the delivery receipt as "damaged" and accept the delivery as-is. Longboard is not responsible for the installation of blemished or damaged material.

### Storage & Handling

Be sure to store the material flat, keep it dry, safe & secure and remain in unopened cartons until ready to be installed. See **Appendix for proper handling and care instructions.**

### Cleaning Recommendations

- Initial and periodic cleaning for best looking product
- Basic methods use a combination of moderate water pressure, soft sponge/brush and a mild detergent (Safe for your hands, safe for the product)

**⚠ NEVER** use aggressive acid or alkaline cleaners on Longboard finishes. Do not use cleaners containing Trisodium Phosphate, Phosphoric Acid, Hydrochloric Acid, Hydrofluoric Acid, Fluorides, or any other compound that is known to react with metal.

**\*See Cleaning Guide for full requirements & cleaning schedule:**  
[longboardproducts.com/resources/care-maintenance.com](http://longboardproducts.com/resources/care-maintenance.com)

### Warranty

Upon substantial completion of the project, register for warranty online here: [longboardproducts.com/warranty](http://longboardproducts.com/warranty)

**⚠** Registration is required for the warranty to be in effect.



## Graffiti Removal

**Standard Woodgrain** 

Use Standard soap & water only

**D2000 Solid Color**

	Prosoco Cleaner	MEK Solvent
Permanent Marker	<input checked="" type="checkbox"/>	<input checked="" type="checkbox"/>
Oil Based Spray Paint	<input checked="" type="checkbox"/>	<input checked="" type="checkbox"/>
Water Based Spray Paint	<input checked="" type="checkbox"/>	<input checked="" type="checkbox"/>
Adhesive Tape	<input checked="" type="checkbox"/>	<input checked="" type="checkbox"/>

 MEK Solvent  
 Prosoco Anti-Graffiti Cleaner

**SPECIAL ORDER - EXT. LEAD TIMES CONTACT LB**

**Anti-Graffiti High Gloss Woodgrain**

	MEK Solvent
Permanent Marker	<input checked="" type="checkbox"/>
Oil Based Spray Paint	<input checked="" type="checkbox"/>
Water Based Spray Paint	<input checked="" type="checkbox"/>
Adhesive Tape	<input checked="" type="checkbox"/>

 MEK Solvent

Note: Cleaning the surface with a cleanser that is not diluted as per instructions, may result in damage to the coating.

## Components

### Components (Typical)

The Privacy Beam system consists of Beams attached to Single Posts and installed onto a support structure or exterior building envelope. For all LB components go to [longboardproducts.com](http://longboardproducts.com).

### Privacy Beam System

Size	Product	24'	End Caps (20/box)
1x3"	Privacy Beam	1X3B.289	1BEC.3
1x5"	Privacy Beam	1X5B.289	1BEC.5
2x2"	Single Post	2X2SP.289	2X2PC.2
2x3"	Double Post	2X3DP.289	2X3PC.3



1x5 Beam



1x3 Beam



End Cap

Mounting Accessories	Qty	SKU
Spacer Block	100, box	2X2SB.N100
1" Spacer Bar Stock Length	1	1X2FB.145
1x3" Spacer Bar	100, box	1X2FB.1
1x5" Spacer Bar	100, box	1X2FB.3
3" Mounting Bracket	100, box	3PSMB.1
#10 Black Screws	100, box	PECS.N100



Mounting Bracket



Single Post

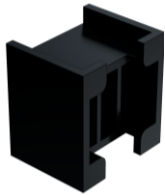

Spacer Block



Spacer Bar

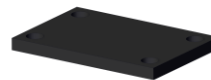

Single Post End Cap







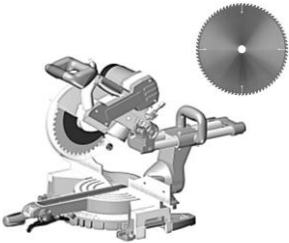

#10 Black Screws  
-used to secure Single  
Post End Cap

## Tools/Cutting/Fastening

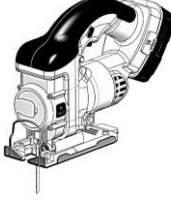
### Tools

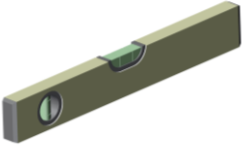
Commonly used tools for Privacy Beam install.

			
Table Saw with Carbide Metal Blade Non-ferrous 60-80T (for cutting aluminum)	Miter Saw with Carbide Metal Blade Non-ferrous 60-80T (for cutting aluminum)	Cordless Drill with clutch	Jig Saw (for protrusions)
			
Rubber Mallet (or Hammer)	Level	#2 Square Drive Bit (Roberston)	3/8" Hex Head Driver

### Cutting

⚠ Always be sure to wear appropriate PPE: eye & hearing protection.

Cut battens using a Miter Saw and Table Saw always allowing for expansion & contraction. Trim the taped/drilled ends of all stock length material by at least **1/2" (12mm) each end** and discard.

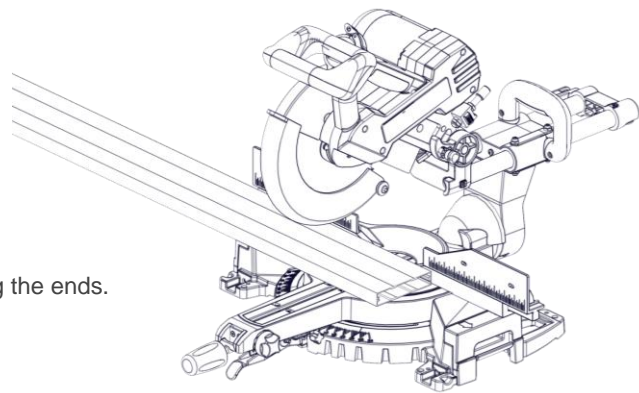
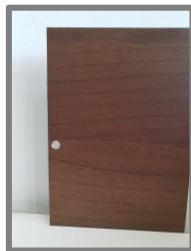

⚠ **DO NOT** Install Privacy Beams without trimming the ends.

### Fastening

Longboard Privacy Beam consists of 1x3 & 1x5 extrusions which are installed onto single posts using mounting brackets for Floating system or spacer blocks for End Frame system. These posts are fastened with #12 fasteners (by others) to a solid secure support structure or substrate, sharp-point screws (for wood substrates) or self-drilling (for metal substrates).

Fasteners must be corrosion resistant and comply with all local building codes.

⚠ All fasteners should be suitable for exterior use and be compatible with the substrate type. **Fasteners should be anchored into a solid secure substrate.**

⚠ See Appendix for project specific fastener spacing: Table 3

### Fastener types

#### RECOMMENDED

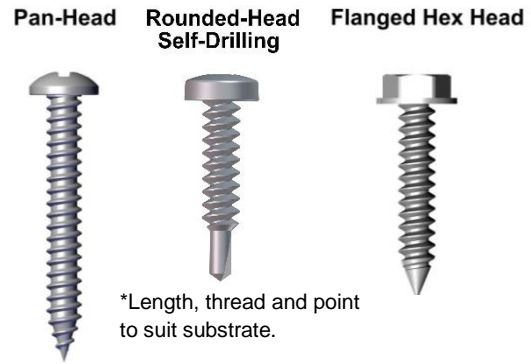

### Floating System

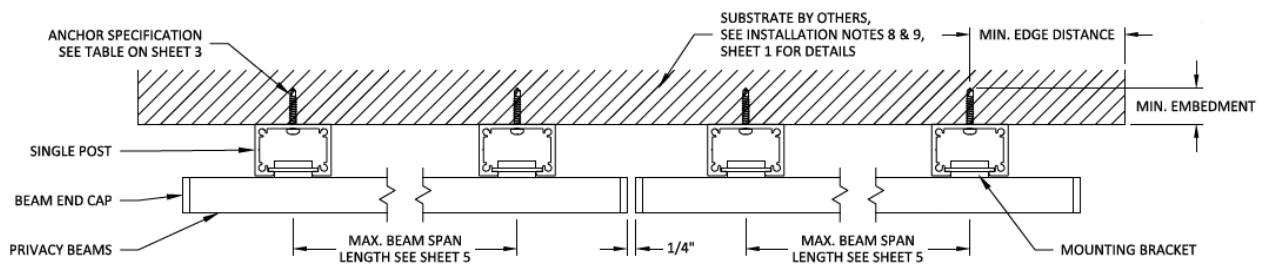

### End Frame System

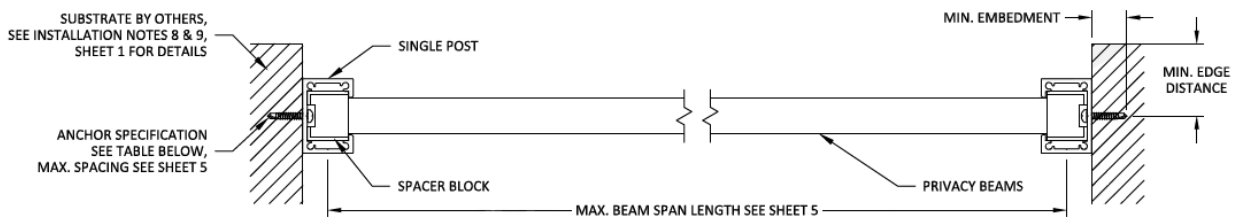

### Framing/Furring requirements

Always consult your local building authority and follow local building code requirements.

See Appendix for framing/furring/sheathing specs: Table 3

## System Install

### Perimeter and field area limitations

Measure and layout your application area to consider Privacy Beam alignment with fixtures, penetrations, and adjacent walls, for desired appearance. The same methodology applies for vertical installations.

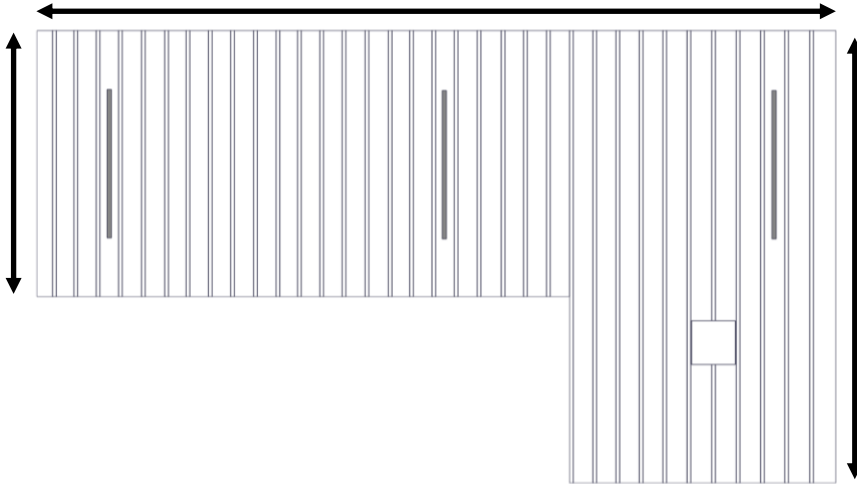

Privacy Beam system requires minimum of two points of attachment.

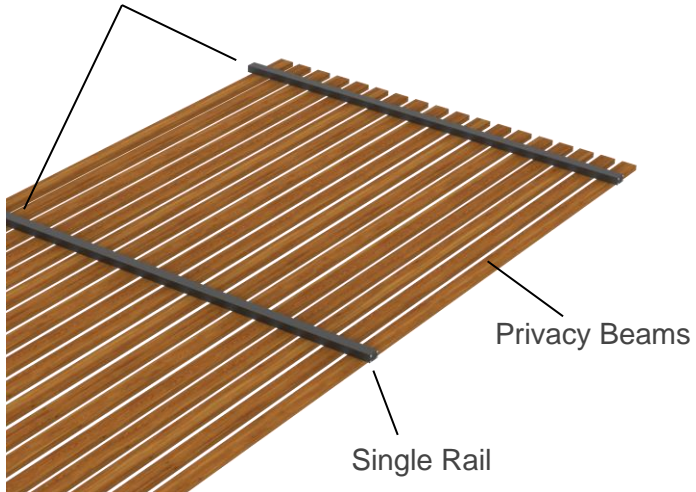

Cantilevers are not to exceed half the allowable span to a maximum of 2'.



## Component assembly overview

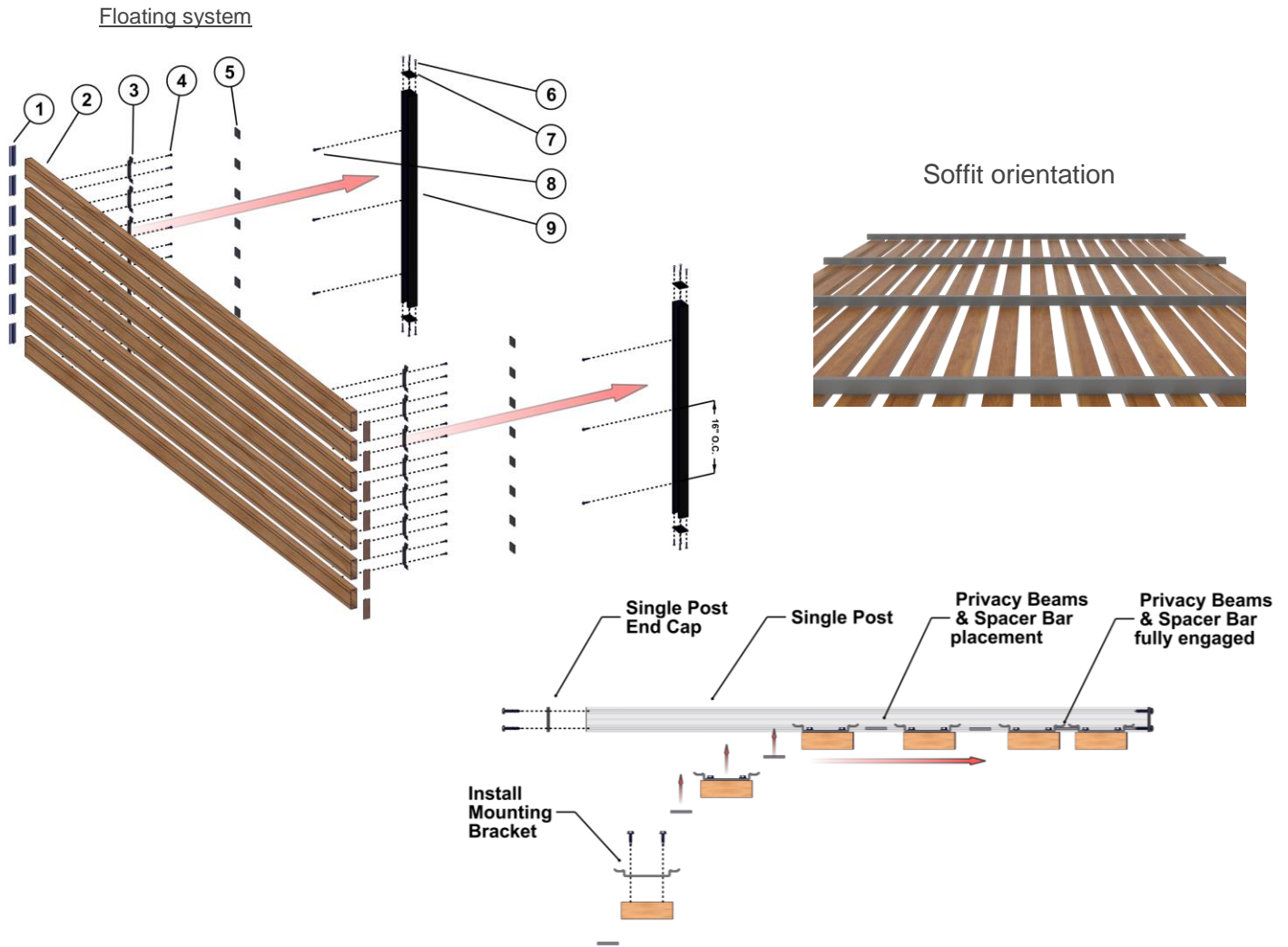

No.	Description	Details	SKU
1	End Cap	-End Caps are friction fit onto ends of the Privacy Beams	1BEC.3, 1BEC.5
2	Privacy Beam	-1"x3" Beam, 1"x5" Beam	1X3B.289, 1x5B.289
3	Mounting Bracket	-Secured onto Beam, (100/box)	3PSMB
4	#10-16x3/4 Tek Hex Head Screw	-For securing the bracket to the Beam Included x 2 with bracket, (200/box)	Included with Mounting Bracket
5	Spacer bar (1" piece)	-For spacing between the Beams 12' length, 1" length- (100/Box), 3" length- (100/Box)	1X2FB.145, 1X2FB.1, 1X2FB.3
6	#10-1 Pan Head Screw	-For securing the Single Post End caps (sold separately)	PECS
7	Single Post End Cap	-Secured onto the end of the Single Posts	2X2PC.2
8	#12 Fastener (by others)	-Used to secure the Posts to the structure. For spacings subject to loading see tables 3 & 4 in appendix.	N/A
9	Single Post	-Installed at 6' O.C. typical spacing, Beams are connected to the posts via the mounting bracket	2X2SP.289

End Frame system

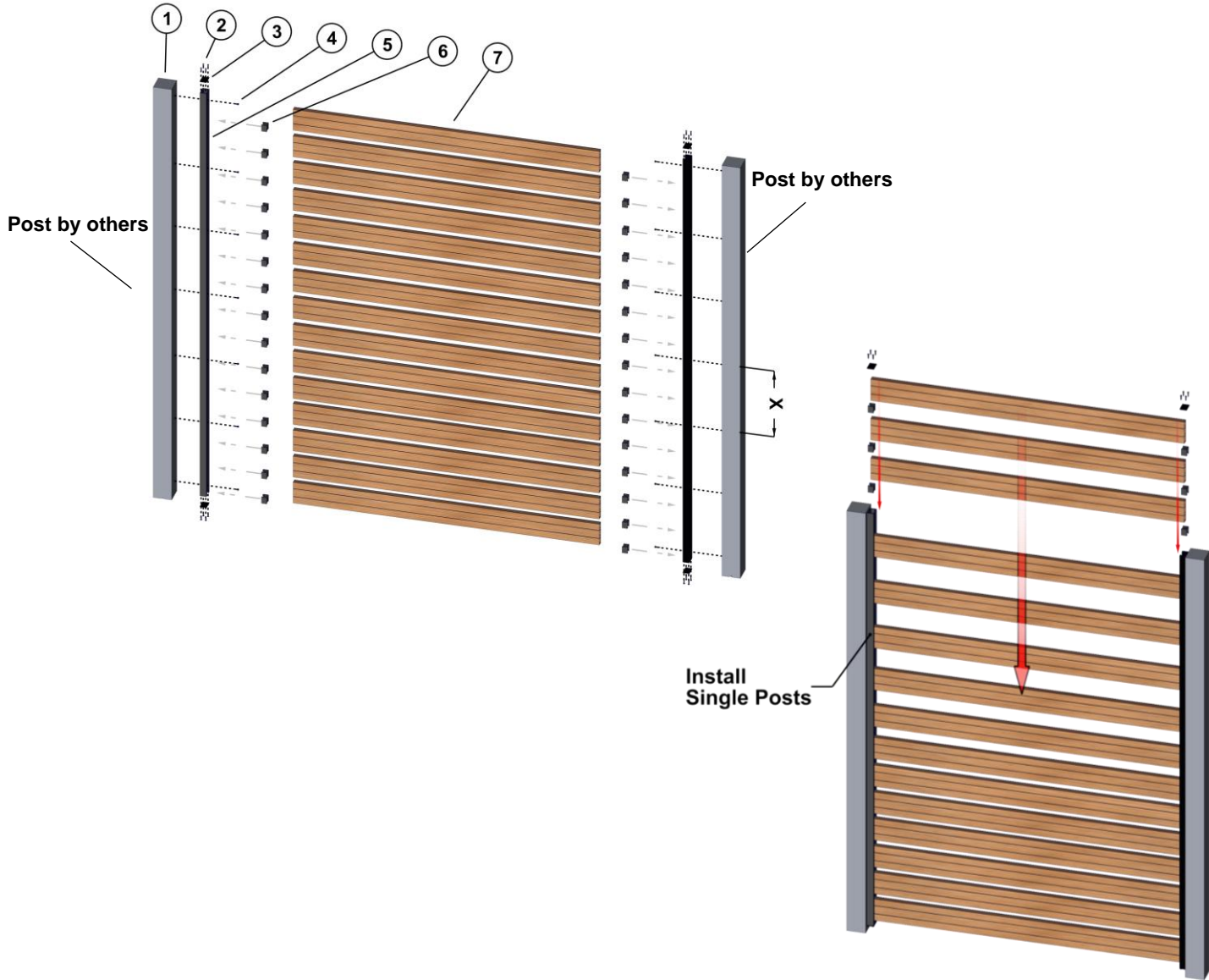

No.	Description	Details	SKU
1	Post or structural member	-By others	N/A
2	#10-1 Pan Head Screw	-For securing the Single Post End caps (sold separately)	PECS
3	Single Post End Cap	-Secured onto the end of the Single Posts	2X2PC.2
4	#12 Fastener (by others)	-Used to secure the Posts to the structure. For spacings subject to loading see tables 3 & 4 in appendix.	N/A
5	Single Post	-Installed at 6' O.C. typical spacing, Beams are connected to the posts via the mounting bracket	2X2SP.289
6	Spacer Block	-For spacing between the Beams (1" spacing)	2X2SB
7	Privacy Beam	-1"x3" Beam, 1"x5" Beam	1X3B.289, 1x5B.289

### Preparation drilling for Install

To prepare the Privacy Beam system for install, predrill the single posts with 1/2" holes every 16" O.C. typical with the first hole approx. 2" in from the end.

\*For fastener max. spacing (X), see table 3 in Appendix for project specific loading.

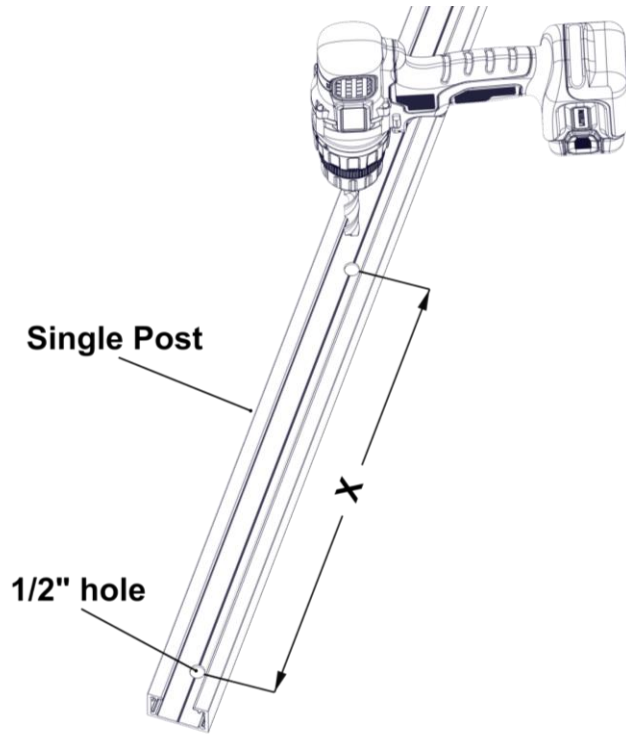

### Anchoring for End Frame System

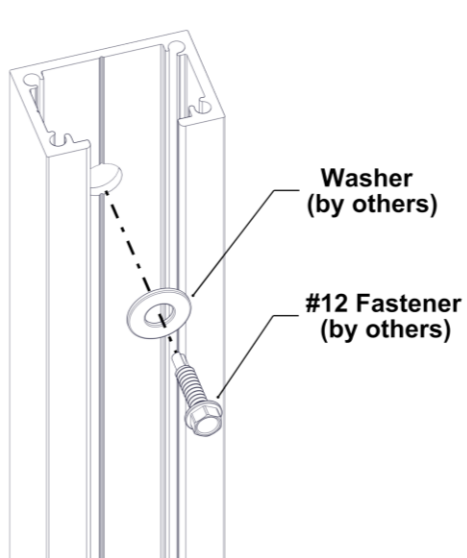

### Anchoring for Floating System

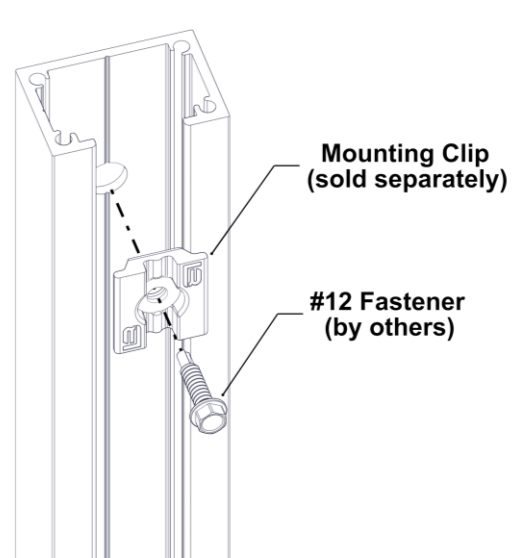

## Install steps

### Floating system

#### Step 1

Layout and install predrilled Privacy Posts onto secure structure. It is good practice to check your installation every 2-3 rows for level/plumb and flat/straight, for best result.

Note: Be sure to fasten in the center of the 1/2" holes to allow for movement each way. Hard fasten near the center of each length to prevent migration of the material over time.



#### Step 2

Install bottom Single Post End Cap and Spacer Bar.

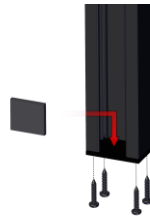

#### Step 3

Fasten Mounting Brackets onto Privacy Beams at desired spacing for the connection to the Single Posts. Use the Die lines as guides for the Mounting Bracket positioning.



**⚠️ Cut off Taped/Drilled Privacy Beam ends (1/2" each end).**

#### Step 4

Install Privacy Beams onto the Single Posts locking into place and continue until all are in place.

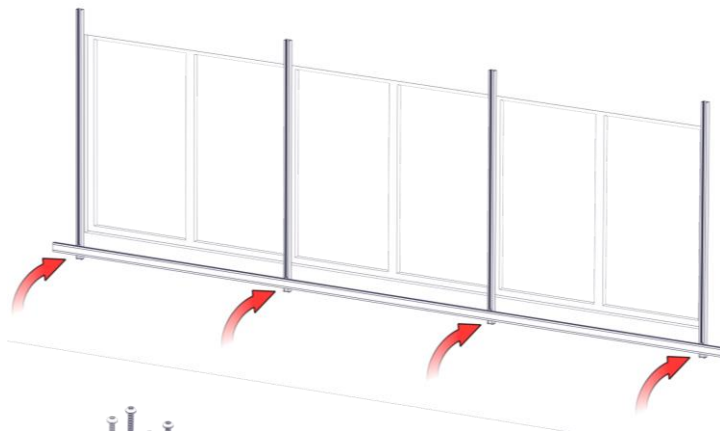

#### Step 5

To finish, install the last Spacer Bar and Single Post End Cap. Then install Privacy Beam End Caps.

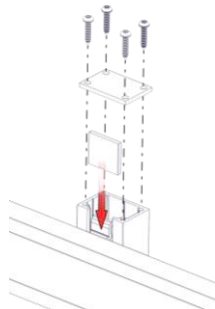

## Install steps

### End Frame system

#### Step 1

Install bottom Single Post End Cap.

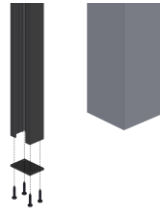

#### Step 2

Install predrilled Privacy Posts onto secure structure. It is good practice to check your installation every 2-3 rows for level/plumb and flat/straight, for best result.

Note: Be sure to fasten in the center of the 1/2" holes to allow for movement each way. Hard fasten near the center of each length to prevent migration of the material over time.

**\*For fastener max. spacing (X), see table 3 in Appendix for project specific loading.**

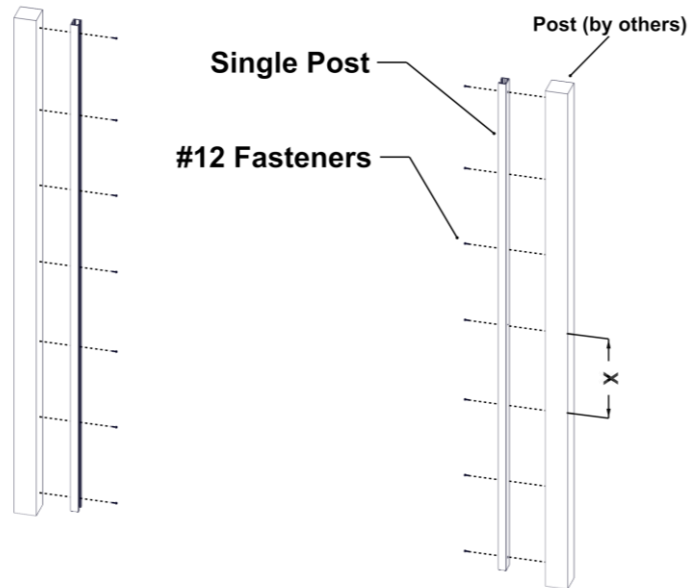

#### Step 3

Place Spacer Block into Post from top of Post and slide down to required location.

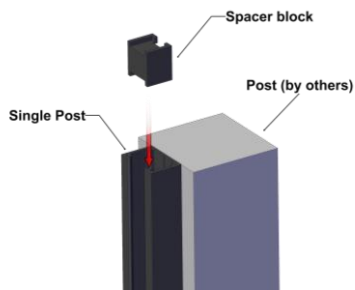

#### Step 4

Cut and place Privacy Beam into Single Posts. Then another Spacer Block and Beam and repeat.

 **Cut off Taped/Drilled Privacy Beam ends (1/2" each end).**

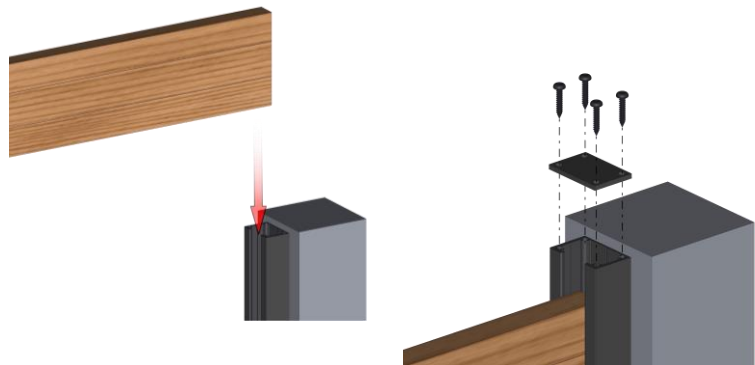

#### Step 5

To finish, install the Single Post End Cap.

## Details

### Butt-Joints

-  **BUTT-JOINTS.** When installing butt-joints, ensure to leave a 1/4" (6mm) min. gap. every 24' (7.3m) min. (See Detail A).

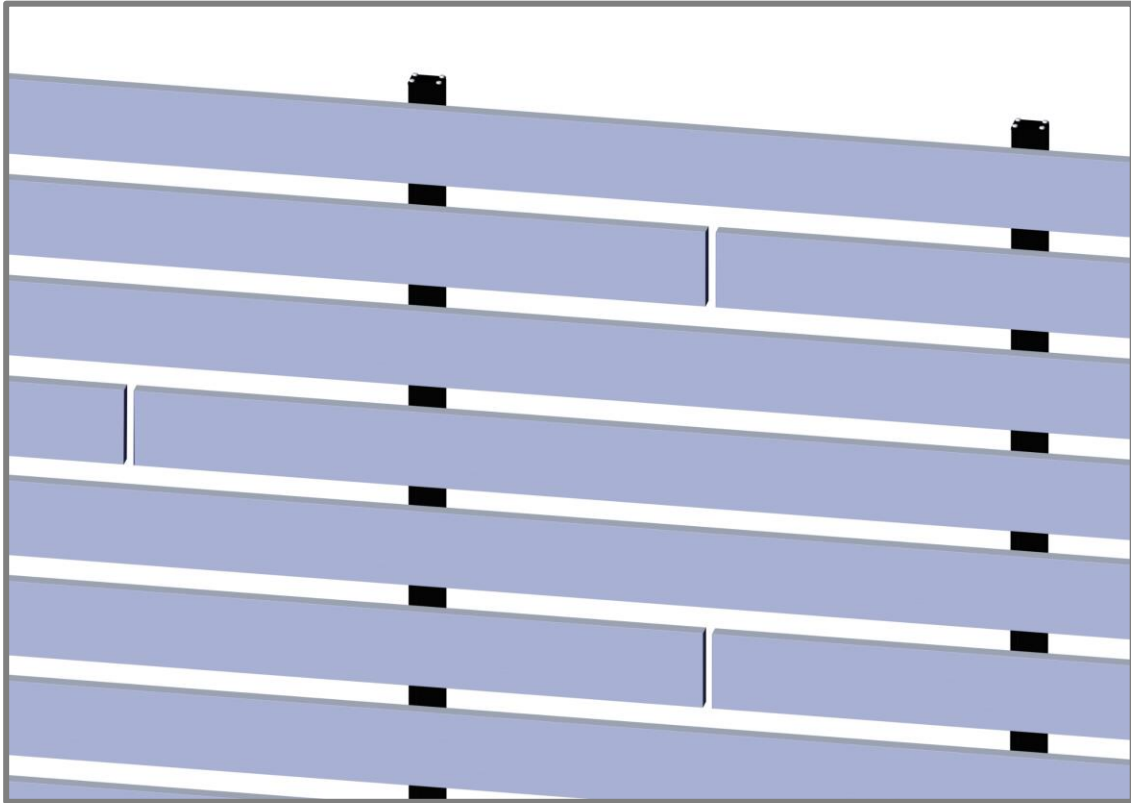

**Detail A**



# Appendix

## Expansion and Contraction Tables

TABLE 1 - IMPERIAL

		AVERAGE TEMPERATURE AT TIME OF CUTTING & INSTALLATION											
°C		-50	-40	-30	-20	-10	0	10	20	30	40	50	
°F		-58	-40	-22	-4	14	32	50	68	86	104	122	
MIN/MAX POST CONSTRUCTION TEMP.	°C	°F	EXPANSION OR CONTRACTION (INCH/FOOT)										
	-50	-58	0.000	-0.003	-0.005	-0.008	-0.011	-0.014	-0.016	-0.019	-0.022	-0.024	-0.027
	-40	-40	0.003	0.000	-0.003	-0.005	-0.008	-0.011	-0.014	-0.016	-0.019	-0.022	-0.024
	-30	-22	0.005	0.003	0.000	-0.003	-0.005	-0.008	-0.011	-0.014	-0.016	-0.019	-0.022
	-20	-4	0.008	0.005	0.003	0.000	-0.003	-0.005	-0.008	-0.011	-0.014	-0.016	-0.019
	-10	14	0.011	0.008	0.005	0.003	0.000	-0.003	-0.005	-0.008	-0.011	-0.014	-0.016
	0	32	0.014	0.011	0.008	0.005	0.003	0.000	-0.003	-0.005	-0.008	-0.011	-0.014
	10	50	0.016	0.014	0.011	0.008	0.005	0.003	0.000	-0.003	-0.005	-0.008	-0.011
	20	68	0.019	0.016	0.014	0.011	0.008	0.005	0.003	0.000	-0.003	-0.005	-0.008
	30	86	0.022	0.019	0.016	0.014	0.011	0.008	0.005	0.003	0.000	-0.003	-0.005
	40	104	0.024	0.022	0.019	0.016	0.014	0.011	0.008	0.005	0.003	0.000	-0.003
	50	122	0.027	0.024	0.022	0.019	0.016	0.014	0.011	0.008	0.005	0.003	0.000

TABLE 2 - METRIC

		AVERAGE TEMPERATURE AT TIME OF CUTTING & INSTALLATION											
°C		-50	-40	-30	-20	-10	0	10	20	30	40	50	
°F		-58	-40	-22	-4	14	32	50	68	86	104	122	
MIN/MAX POST CONSTRUCTION TEMP.	°C	°F	EXPANSION OR CONTRACTION (MM/METER)										
	-50	-58	0.000	-0.230	-0.460	-0.690	-0.920	-1.150	-1.380	-1.610	-1.840	-2.070	-2.300
	-40	-40	0.230	0.000	-0.230	-0.460	-0.690	-0.920	-1.150	-1.380	-1.610	-1.840	-2.070
	-30	-22	0.460	0.230	0.000	-0.230	-0.460	-0.690	-0.920	-1.150	-1.380	-1.610	-1.840
	-20	-4	0.690	0.460	0.230	0.000	-0.230	-0.460	-0.690	-0.920	-1.150	-1.380	-1.610
	-10	14	0.920	0.690	0.460	0.230	0.000	-0.230	-0.460	-0.690	-0.920	-1.150	-1.380
	0	32	1.150	0.920	0.690	0.460	0.230	0.000	-0.230	-0.460	-0.690	-0.920	-1.150
	10	50	1.380	1.150	0.920	0.690	0.460	0.230	0.000	-0.230	-0.460	-0.690	-0.920
	20	68	1.610	1.380	1.150	0.920	0.690	0.460	0.230	0.000	-0.230	-0.460	-0.690
	30	86	1.840	1.610	1.380	1.150	0.920	0.690	0.460	0.230	0.000	-0.230	-0.460
	40	104	2.070	1.840	1.610	1.380	1.150	0.920	0.690	0.460	0.230	0.000	-0.230
	50	122	2.300	2.070	1.840	1.610	1.380	1.150	0.920	0.690	0.460	0.230	0.000

**TABLE 3**

1X3 & 1X5 PRIVACY BEAMS		PSF (Factored / Ultimate)										
		20	30	40	50	60	70	80	90	100	110	120
1x3 Beam*	1x5 Beam*											
POST SPACING (FT)	4'											1x3 Beam 1x5 Beam
	6'					1x5 Beam						
	7'			1x3 Beam								
	8'	1x3 Beam Only										

\*CANTILEVERS are not to exceed half (1/2) the allowable span to a maximum of 2'

*Calculations are using L/180 deflection limits*

SINGLE POST		FASTENER SPACING (INCHES)					
		FLOATING SYSTEM			END FRAME SYSTEM		
		WOOD	STEEL/ ALUM.	CONCRETE/ CMU	WOOD	STEEL/ ALUM.	CONCRETE/ CMU
POST SPACING (FT)	4'	16"	6"	6"	6"	14"	6"
	6'	18"	7"	7"	7"	16"	6"
	7'	24"	10"	10"	10"	24"	10"
	8'	24"	12"	12"	12"	24"	11"

\* 1x3 Only

SUBSTRATE TYPE	SUBSTRATE REQUIREMENTS	ANCHOR DESCRIPTION	MIN. EMBEDMENT	MIN. EDGE DISTANCE
WOOD	Min. specific gravity = 0.55 wood	#12 Wood Screw	1-1/2"	1"
STEEL	Min. 1/16" thick, Min. Fy=36 ksi.	#12 Self-Drilling or Self-Tapping Screw (Grade 5)	3 threads penetration past metal structure	1/2"
ALUMINIUM	Min. 1/8", Min. 6063-T5			
CONCRETE	Min. 3000 psi	3/16" ITW Tapcon	1-1/2"	2"
HOLLOW/GROUT-FILLED CMU	Conforms to ASTM C-90, with Min. compressive strength of 2000 psi		1-1/4"	3"

**GENERAL NOTES:**

- This product has been designed and manufactured to comply with the current Florida Building Code (FBC), **INCLUDING** HVHZ and has been evaluated according to the following:
  - Section 1709.8
  - ASTM E8-16
- Adequacy of the structural concrete/masonry and 2X framing as a main wind force resisting system capable of withstanding and transferring applied product loads to the foundation is the responsibility of the engineer or architect of record for the project of installation.
- Substrate shall be designed and anchored to properly transfer all loads to the structure. Buck design and installation is the responsibility of the engineer or architect of record for the project of installation.
- The installation details described herein are generic and may not reflect actual conditions for a specific site. If site conditions cause installation to deviate from the requirements detailed herein, a licensed engineer or architect shall prepare site specific documents for use with this document.
- The Privacy Beam System has not been designed to be a life-safety item. Designs of this nature are the responsibility of the engineer or architect of record.

**INSTALLATION NOTES:**

- One (1) installation anchor is required at each location. Minimum of two (2) anchors per batten.
- Spacing is from fastener center to center.
- The number of installation anchors per the table is the minimum number of anchors to be used for product installation.
- Install individual installation anchors within a tolerance of +/- 1/2" of the specified spacings. Tolerances are not cumulative from one installation anchor to the next.
- Minimum embedment and edge distance exclude wall finishes, including but not limited to stucco, foam, brick veneer, sheathing and siding.
- Installation anchors and associated hardware must be made of corrosion resistant material or have a corrosion resistant coating. Common fastener types can be equal or better to a & b listed below:
  - Zinc plated fasteners for moderate climate zones
  - 316 Stainless Steel fasteners for coastal climate zones
- For hollow block and grout filled CMU block, do not install installation anchors into mortar joints. Edge distance is measured from free edge of block or edge of mortar joint into face shell of block.
- Installation anchors shall be installed in accordance with anchor manufacturer's installation instructions, and anchors shall not be used in substrates with strengths less than the minimum strength specified by the anchor manufacturer.



## Proper Handling of Longboard Products



To help avoid injury and product damage, Longboard products require proper handling to and from storage areas during installation. When carrying or installing any products it is recommended that they be moved or carried by at least two people with each support point approximately 4ft from the ends. **Carrying products without proper support can cause excessive bending which may damage the appearance or finish of the product.** Any short cut lengths should also be carried on edge while supporting the material. See below for details.

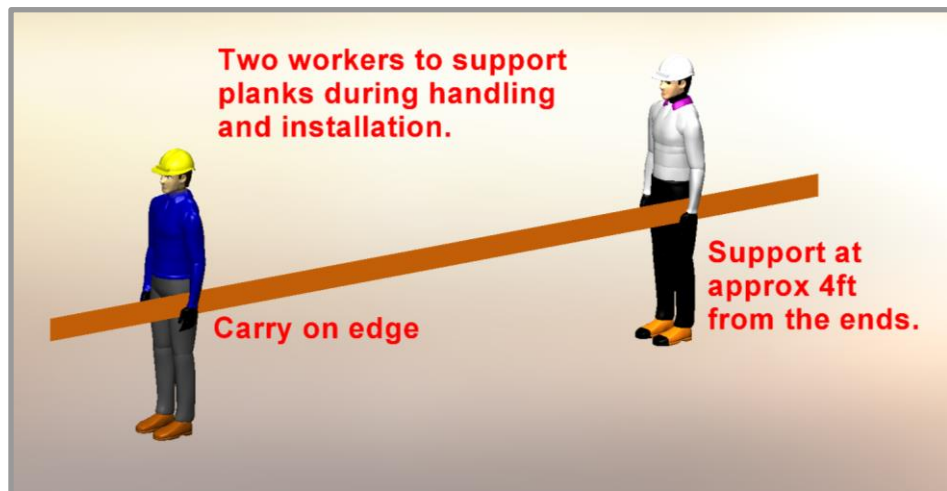
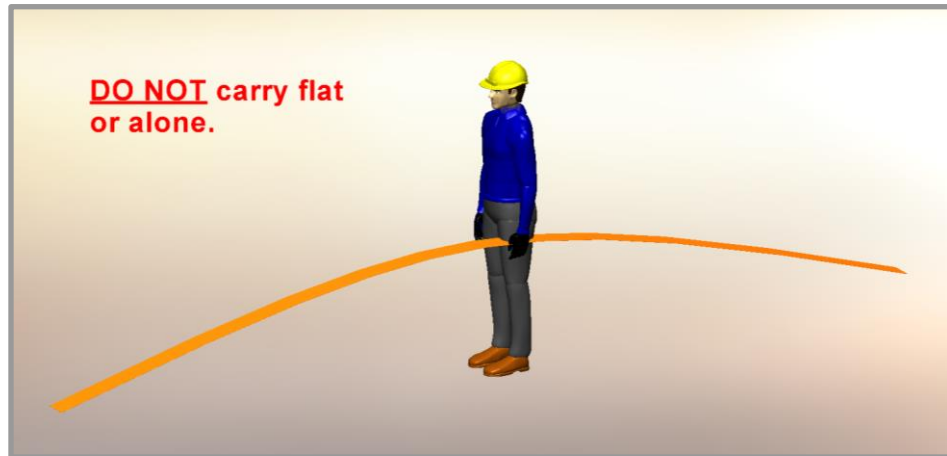

### ⚠️ Delivery, Storage & Handling ⚠️

- Always inspect the delivery for damage and contact LB ASAP if there are any issues: [info@longboardproducts.com](mailto:info@longboardproducts.com) or 1-800-604-0343 and include your PO# and any pictures if possible. Longboard is not responsible for the installation of blemished or damaged material.
- Be sure to store the material flat, keep it dry, safe & secure and remain in unopened cartons until ready to be installed.
- Always wear appropriate PPE when handling products.



Longboard Architectural Products Inc.  
© Longboard Architectural Products Inc. All rights reserved.

Longboard® is a registered trademark of Longboard Architectural Products Inc.

Longboard  
1777 Clearbrook Road  
Abbotsford, BC V2T 8X8  
Canada  
[longboardproducts.com](http://longboardproducts.com)

Every effort has been made to ensure that the information in these installation guidelines is accurate. Longboard is not responsible for printing or clerical errors.

For more information, contact client care at [info@longboardproducts.com](mailto:info@longboardproducts.com) or call toll free 1-800-604-0343.