

# ICC-ES Evaluation Report

ESR-4183

Reissued April 2026



This report also contains:

- City of LA Supplement
- CA Supplement
- FL Supplement

Subject to renewal April 2027

ICC-ES Evaluation Reports are not to be construed as representing aesthetics or any other attributes not specifically addressed, nor are they to be construed as an endorsement of the subject of the report or a recommendation for its use. There is no warranty by ICC Evaluation Service, LLC, express or implied, as to any finding or other matter in this report, or as to any product covered by the report.

Copyright © 2026 ICC Evaluation Service, LLC. All rights reserved.

<p><b>DIVISION: 05 00 00—METALS</b></p> <p><b>Section: 05 50 00—Metal Fabrications</b></p>	<p><b>REPORT HOLDER:</b></p> <p><b>LONGBOARD ARCHITECTURAL PRODUCTS INC.</b></p>  <p><b>LONGBOARD</b> INSPIRING ARCHITECTURE</p>	<p><b>EVALUATION SUBJECT:</b></p> <p><b>LONGBOARD SYSTEMS</b></p>	
--	---	---	---

## 1.0 EVALUATION SCOPE

**Compliance with the following codes:**

- 2024, 2021, 2018 and 2015 [International Building Code® \(IBC\)](#)
- 2024, 2021, 2018 and 2015 [International Residential Code® \(IRC\)](#)

**Properties evaluated:**

- Surface-burning characteristics
- Noncombustibility

## 2.0 USES

The Longboard Systems: Longboard Privacy Screen System, Longboard Link & Lock™ System, and Longboard Link & Lock™ HD System, are used in exterior applications as a partition to provide a visual barrier and may also be used as an interior finish in accordance with IBC Section 803 or IRC Section R302.9, as applicable. See [Figures 1](#) and [2](#).

## 3.0 DESCRIPTION

The Longboard Privacy Screen System is constructed of rectangular aluminum members (see [Figure 3](#)) attached to aluminum posts. The posts may be attached to walls or mounted on base plates. Miscellaneous items that may be used in different installations include a bracket, plastic spacer, flat-bar spacer, post cap, and tube cap as shown in [Figure 4](#).

The Longboard Link & Lock™ System and Longboard Link & Lock™ HD System are constructed of matching self-mating aluminum extrusions (see [Figure 5](#)), mechanically fastened to substrates (by others) at various spacings. Miscellaneous items that may be used in different installations include a mounting clip, end cap, stiffener, and end mount as shown in [Figure 6](#).

The aluminum members ([Figures 3](#) and [5](#)) are fabricated from 6063 T5 aluminum. They are noncombustible based on testing in accordance with ASTM E136. With the powder coating applied, they have a flame spread index of less than 25 and a smoke-developed index of less than 450 when tested in accordance with ASTM E2768 (which includes ASTM E84). The members with the powder coating applied are noncombustible materials in accordance with the Exception to Section 703.3.1 of the 2021 IBC and composite materials in accordance with 2018 and 2015 IBC Section 703.5.2.

The aluminum members with the powder coating meet the requirements for a Class A interior finish.

## 4.0 INSTALLATION

The Longboard Privacy Screen System must be installed in accordance with this report and the manufacturer's published installation instructions.

## 5.0 CONDITIONS OF USE:

The Longboard Systems described in this report comply with, or are a suitable alternative to what is specified in, those codes listed in Section 1.0 of this report, provided the installation complies with this report, subject to the following conditions:

- 5.1 Installation must comply with the requirements of the applicable code, this report and the manufacturer's published installation instructions. In the event of conflict between this report and the manufacturer's published installation instructions, this report governs.
- 5.2 Use of the Longboard Systems is for visual purposes only. Use as an exterior wall veneer is outside the scope of this report.

## 6.0 EVIDENCE SUBMITTED

- 6.1 Manufacturer's descriptive literature and published installation instructions.
- 6.2 Data in accordance with ASTM E136.
- 6.3 Data in accordance with ASTM E2768.
- 6.4 Quality documentation in accordance with the [ICC-ES Acceptance Criteria for Quality Documentation \(AC10\)](#).

## 7.0 IDENTIFICATION

- 7.1 Each bundle of the Longboard System material described in this report is identified with a label that contains the manufacturer's name, the product name (Longboard Privacy Screen System, Longboard Link & Lock™ System, or Longboard Link & Lock™ HD System), the profile code, and this evaluation report number (ESR-4183).
- 7.2 The report holder's contact information is the following:

**LONGBOARD ARCHITECTURAL PRODUCTS INC.**  
**#120-1777 CLEARBROOK ROAD**  
**ABBOTSFORD, BRITISH COLUMBIA V2T 5X5**  
**CANADA**  
**(604) 607-6630**  
[www.longboardproducts.com](http://www.longboardproducts.com)  
[info@longboardproducts.com](mailto:info@longboardproducts.com)

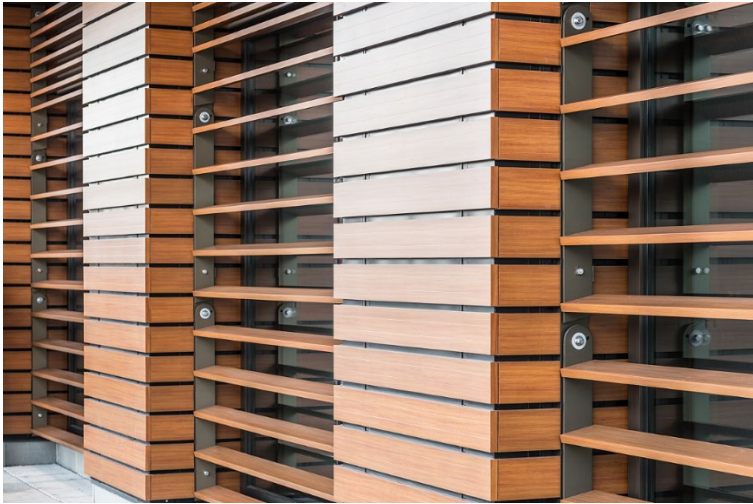

FIGURE 1—LONGBOARD PRIVACY SCREEN



FIGURE 2—LONGBOARD LINK & LOCK™ AND LONGBOARD LINK & LOCK™ HD SYSTEMS

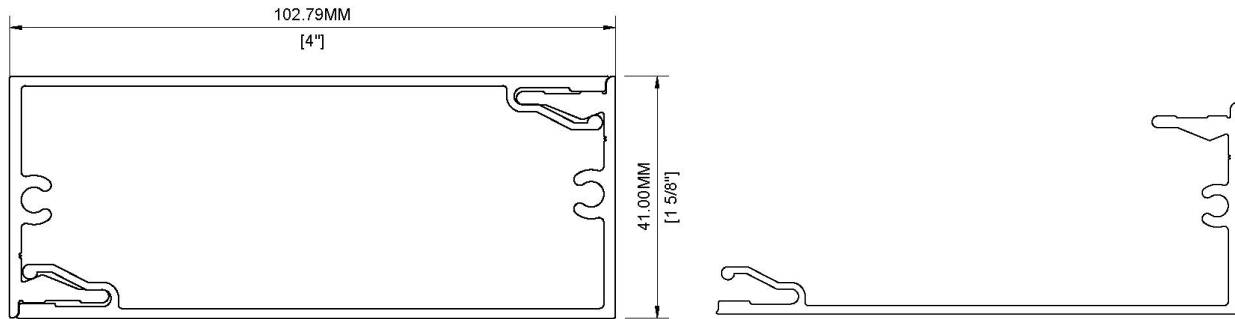

FIGURE 3—LINK & LOCK BATTENS FOR THE LONGBOARD PRIVACY SCREEN SYSTEM (4-INCH PIECE TUBE AS SHOWN, ALSO AVAILABLE IN 2, 6 AND 8-INCH TUBES)

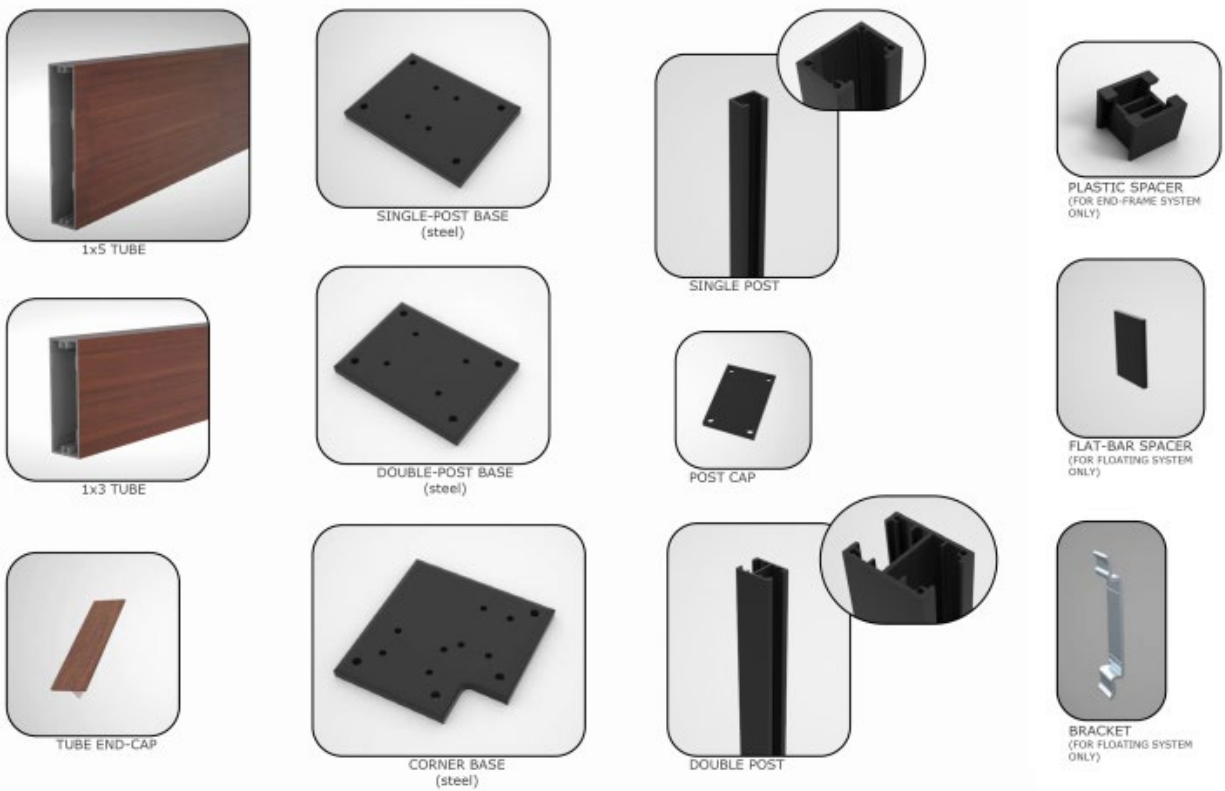
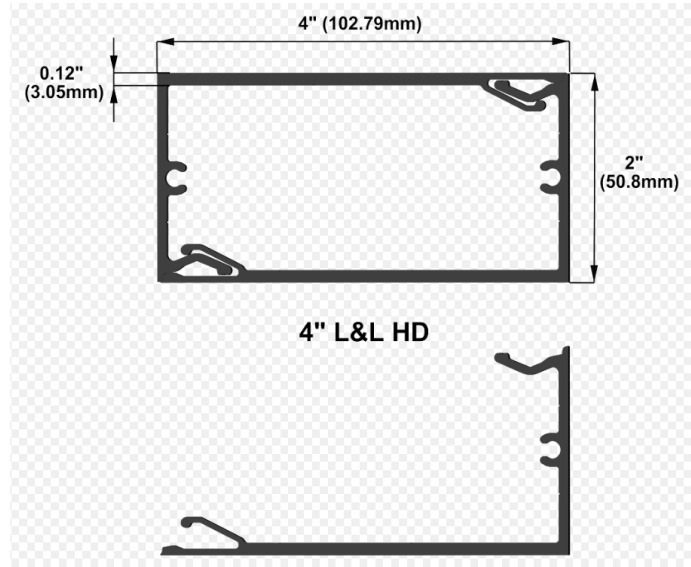

FIGURE 4—LONGBOARD PRIVACY SCREEN SYSTEM MISCELLANEOUS ITEMS



Notes:

- Link & Lock™ System Battens are available in 2x2, 4x4, and 4x6-inch Tubes.
- Link & Lock™ HD System Battens are available in 2x4, 2X6, and 2X8-inch Tubes.

FIGURE 5— LONGBOARD LINK & LOCK™ AND LINK & LOCK™ HD SYSTEMS ALUMINUM BATTENS

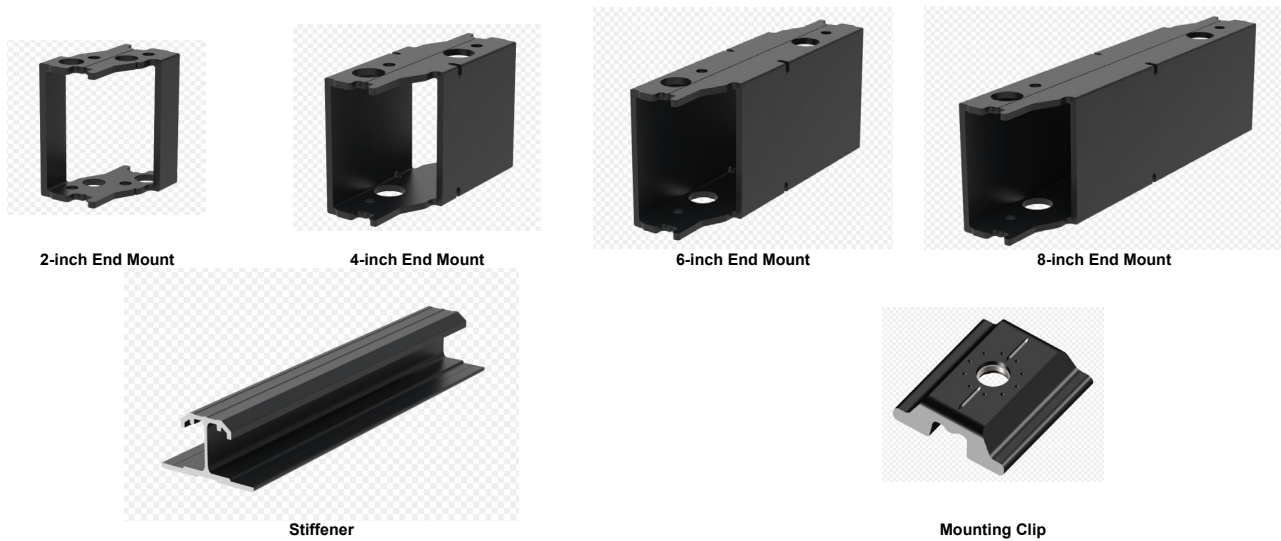

FIGURE 6—LONGBOARD LINK & LOCK™ AND LINK & LOCK™ HD SYSTEMS MISCELLANEOUS ITEMS

**DIVISION: 05 00 00—METALS**  
**Section: 05 50 00—Metal Fabrications**

**REPORT HOLDER:**

**LONGBOARD ARCHITECTURAL PRODUCTS INC.**

**EVALUATION SUBJECT:**

**LONGBOARD PRIVACY SCREEN SYSTEM**

**1.0 REPORT PURPOSE AND SCOPE****Purpose:**

The purpose of this evaluation report supplement is to indicate that Longboard Privacy Screen System, described in ICC-ES evaluation report [ESR-4183](#), has also been evaluated for compliance with the codes noted below as adopted by the Los Angeles Department of Building and Safety (LADBS).

**Applicable code editions:**

- 2023 *City of Los Angeles Building Code* ([LABC](#))
- 2023 *City of Los Angeles Residential Code* ([LARC](#))

**2.0 CONCLUSIONS**

The Longboard Privacy Screen System, described in Sections 2.0 through 7.0 of the evaluation report [ESR-4183](#), complies with the LABC Sections 703.3.1 and 803.1.2 for Class A finish, and the LARC R302.9, and are subjected to the conditions of use described in this supplement.

**3.0 CONDITIONS OF USE**

The Longboard Privacy Screen System, described in this evaluation report must comply with all of the following conditions:

- All applicable sections in the evaluation report [ESR-4183](#).
- The design, installation, conditions of use and identification are in accordance with the 2021 *International Building Code*® (IBC) provisions noted in the evaluation report [ESR-4183](#).
- The design, installation and inspection are in accordance with additional requirements of LABC Chapters 16 and 17, as applicable.
- The Longboard Privacy Screen System may be used in the exterior design and construction of new buildings located in a Fire Hazard Severity Zone within State Responsibility Areas or Wildland–Urban Interface Fire Area, provided installation is in accordance with the 2021 *International Building Code*® (IBC) provisions noted in the evaluation report and the additional requirements of CBC Sections 701A.3 and 710A. The Longboard Privacy Screen System complies with the noncombustible material performance requirements of CBC Section 704A.4 (Item 1) when tested in accordance with ASTM E136 and may be used in the exterior design and construction of exterior walls in new buildings located in a Fire Hazard Severity Zone within State Responsibility Areas or Wildland–Urban Interface Fire Area.
- The Longboard Privacy Screen System may be used in the exterior design and construction of new buildings located in a Fire Hazard Severity Zone within State Responsibility Areas or Wildland–Urban Interface Fire Area, provided installation is in accordance with the 2021 *International Residential Code*® (IRC) provisions noted in the evaluation report and the additional requirements of CRC Sections R337.1.3 and R337.10. The Longboard Privacy Screen System complies with the noncombustible material performance requirements of CRC Section R337.4.4 (Item 1) when tested in accordance with ASTM E136 and may be used in the exterior design and construction of exterior walls in new buildings located in a Fire Hazard Severity Zone within State Responsibility Areas or Wildland–Urban Interface Fire Area.

This supplement expires concurrently with the evaluation report, reissued April 2026.

**DIVISION: 05 00 00—METALS**  
**Section: 05 50 00—Metal Fabrications**

**REPORT HOLDER:**

**LONGBOARD ARCHITECTURAL PRODUCTS INC.**

**EVALUATION SUBJECT:**

**LONGBOARD PRIVACY SCREEN SYSTEM**

**1.0 REPORT PURPOSE AND SCOPE****Purpose:**

The purpose of this evaluation report supplement is to indicate that Longboard Privacy Screen System, described in ICC-ES evaluation report [ESR-4183](#), has also been evaluated for compliance with the codes noted below.

**Applicable code editions:**

- 2022 California Building Code (CBC)

For evaluation of applicable chapters adopted by the California Office of Statewide Health Planning and Development (OSHPD) AKA: California Department of Health Care Access and Information (HCAI) and the Division of State Architect (DSA), see Sections 2.1.1 and 2.1.2 below.

- 2022 California Residential Code (CRC)

**2.0 CONCLUSIONS****2.1 CBC:**

The Longboard Privacy Screen System, described in Sections 2.0 through 7.0 of the evaluation report [ESR-4183](#), complies with CBC Sections 703.3.1 and 803.1.2, provided the design and installation are in accordance with the 2021 *International Building Code*® (IBC) provisions noted in the evaluation report and the additional requirements of the CBC.

**2.1.1 OSHPD:** The applicable OSHPD Sections and Chapters of the CBC are beyond the scope of this supplement.

**2.1.2 DSA:** The applicable DSA Sections and Chapters of the CBC are beyond the scope of this supplement.

The Longboard Privacy Screen System may be used in the exterior design and construction of new buildings located in a Fire Hazard Severity Zone within State Responsibility Areas or Wildland–Urban Interface Fire Area, provided installation is in accordance with the 2021 *International Building Code*® (IBC) provisions noted in the evaluation report and the additional requirements of CBC Sections 701A.3 and 710A. The Longboard Privacy Screen System complies with the noncombustible material performance requirements of CBC Section 704A.4 (Item 1) when tested in accordance with ASTM E136 and may be used in the exterior design and construction of exterior walls in new buildings located in a Fire Hazard Severity Zone within State Responsibility Areas or Wildland–Urban Interface Fire Area.

**2.2 CRC:**

The Longboard Privacy Screen System, described in Sections 2.0 through 7.0 of the evaluation report [ESR-4183](#), complies with CRC Section R302.9, provided the design and installation are in accordance with the 2021 *International Residential Code*® (IRC) provisions noted in the evaluation report.

The Longboard Privacy Screen System may be used in the exterior design and construction of new buildings located in a Fire Hazard Severity Zone within State Responsibility Areas or Wildland–Urban Interface Fire Area, provided installation is in accordance with the 2021 *International Residential Code*® (IRC) provisions noted in the evaluation report and the additional requirements of CRC Sections R337.1.3 and R337.10. The Longboard Privacy Screen System complies with the noncombustible material performance requirements of CRC Section R337.4.4 (Item 1) when tested in accordance with ASTM

E136 and may be used in the exterior design and construction of exterior walls in new buildings located in a Fire Hazard Severity Zone within State Responsibility Areas or Wildland–Urban Interface Fire Area.

The products included in this supplement have not been evaluated for compliance with the *International Wildland–Urban Interface Code*<sup>®</sup>.

This supplement expires concurrently with the evaluation report, reissued April 2026.

**DIVISION: 05 00 00—METALS**  
**Section: 05 50 00—Metal Fabrications**

**REPORT HOLDER:****LONGBOARD ARCHITECTURAL PRODUCTS INC****EVALUATION SUBJECT:****LONGBOARD PRIVACY SCREEN SYSTEM****1.0 REPORT PURPOSE AND SCOPE****Purpose:**

The purpose of this evaluation report supplement is to indicate that Longboard Privacy Screen System, described in ICC-ES evaluation report [ESR-4183](#), has also been evaluated for compliance with the codes noted below.

**Applicable code editions:**

- 2023 *Florida Building Code—Building*
- 2023 *Florida Building Code—Residential*

**2.0 CONCLUSIONS**

The Longboard Privacy Screen System, described in Sections 2.0 through 7.0 of ICC-ES evaluation report [ESR-4183](#), complies with the *Florida Building Code—Building* and *Florida Building Code—Residential*. The design requirements must be determined in accordance with the *Florida Building Code—Building* or the *Florida Building Code—Residential*, as applicable. The installation requirements noted in ICC-ES evaluation report [ESR-4183](#) for the 2021 *International Building Code*® and the 2021 *International Residential Code*® meet the requirements of the *Florida Building Code—Building* and the *Florida Building Code—Residential*.

Use of the Longboard Privacy Screen System for compliance with the High-Velocity Hurricane Zone provisions of the *Florida Building Code—Building* and the *Florida Building Code—Residential* has not been evaluated, and is outside the scope of this supplemental report.

For products falling under Florida Rule 61G20-3, verification that the report holder's quality assurance program is audited by a quality assurance entity approved by the Florida Building Commission for the type of inspections being conducted is the responsibility of an approved validation entity (or the code official when the report holder does not possess an approval by the Commission). Florida Rule 61G20-3 is applicable to products and/or systems which comprise the building envelope and structural frame for compliance with the structural requirements of the Florida Building Code.

This supplement expires concurrently with the evaluation report, reissued April 2026.