



LONGBOARD®
INSPIRING ARCHITECTURE

Tongue & Groove Planks Textured Cladding

CASTELLATION

Installation Guidelines



Table of Contents

Critical Details	3
Material Specifications	4
Finishes	4
Material ordering and deliveries	4
Storage and handling	4
Cleaning Recommendations	4
Warranty	5
Graffiti Removal	5
Components	6
Components (Typical)	6
Tools/Cutting/Fastening	7
Tools	7
Cutting	7
Fastening/Fastener types	8
Framing/Furring requirements	8
Fastening options onto exterior insulation/materials	9
System Install	10
Perimeter area and field limitations	10
Component assembly	11
Castellation Planks	11
Castellation Planks with Link & Lock	12
Plank Install	12
Link & Lock Install	13
Details	14
Single Butt-Joints	14-15
Multiple Floating Butt-Joints	16
Appendix	17
Tables 1&2 - Expansion & contraction	17
Table 3 - Castellation Load Table	18
Tables 4-7 - Link & Lock Allowable Span	19-22
Radius Table	23
Handling and care of products	24
Blank Page	25
Contact Info	26

CRITICAL DETAILS

CUT TAPED/DRILLED ENDS

CUT taped/drilled ends.

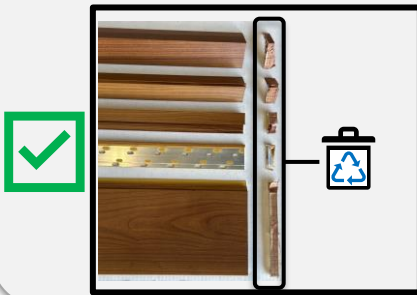

BUTT- JOINTS

Use Butt-Joint Kit to avoid gaps.

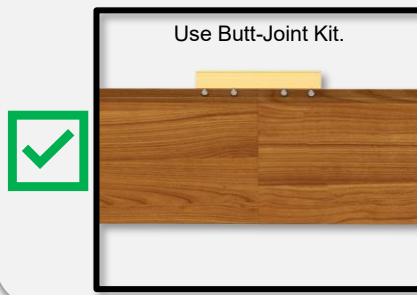
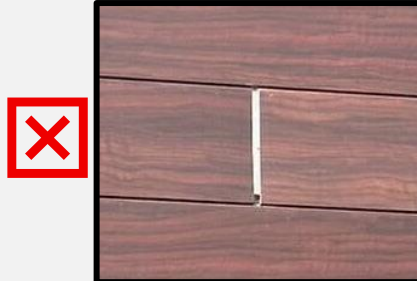

THERMAL MOVEMENT

Confirm allowance for thermal expansion & contraction and confirm trim/caps cover.

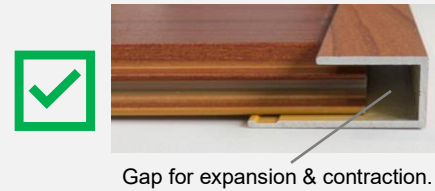

FASTENERS

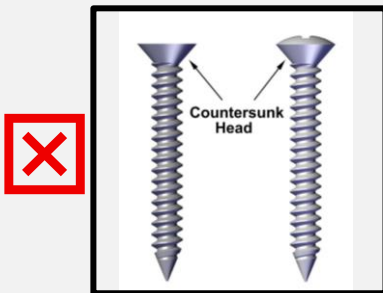

HARD FASTENING

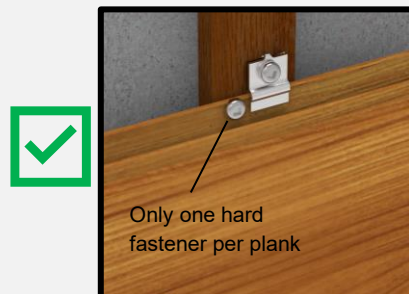
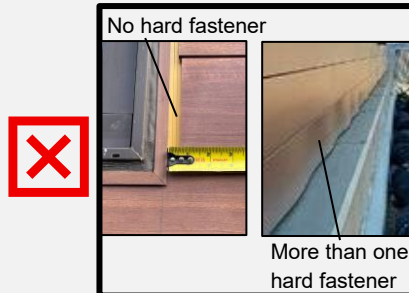

COMPRESSION JOINTS

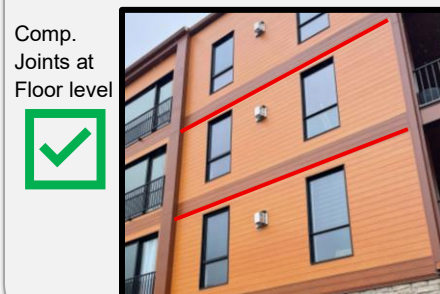
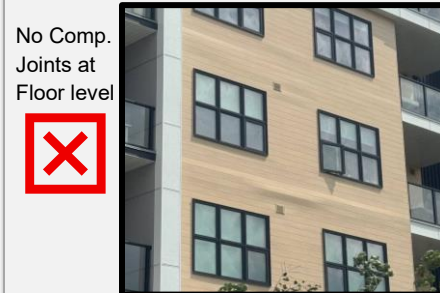

Material Specifications

Finishes

- Longboard Products are available in a wide range of powder coated finishes.
- Custom solid colors are available upon request.
- Longboard woodgrains have a repeat pattern, shipped in sets mated back-to-back in each box. Install these as they come out of the box, as an A&B pattern staggering each plank approx. 1-2' (305-610mm) from the previous plank to achieve a random pattern aesthetic. It is recommended to create an onsite mock-up to produce a suitable pattern.
- All Castellated Planks in woodgrain require L&L attached.
- Longboard Products are not recommended for use on marine applications in direct contact with salt water.

Longboard extruded products are produced 1" (25mm) oversized, as one end is drilled for the coating process, and both ends have 1/2" (12mm) of masking tape (woodgrains only) which must be cut off for best results. Longboard Cladding is to be installed outboard of a weather resistant barrier, including all flashings, following code, and building requirements.

Material Ordering & Delivery

- | | |
|--------------|---|
| • Packaging: | Planks are sold in box quantities:
4" Castellated Planks: 64 SQ FT/Box (8/24's, 192 LF) w. 96 Quick-Screen Clips included
8" Castellated Planks: 128 SQ FT/Box (8/24's, 192 LF) w. 96 Quick-Screen Clips included
Trim Components are sold individually by the 12' (3.7m) length. |
| • Shipping: | Delivered on 24' (7.3m) long skids weighing up to 2000 lbs. A mechanical lift with forks is required on site to receive the order. |
| • QC: | Always inspect the delivery for damage and contact LB ASAP if there are any issues: info@longboardproducts.com or 1-800-604-0343 and include your PO# and any pictures if possible. Mark the delivery receipt as "damaged" and accept the delivery as-is. Longboard is not responsible for the installation of blemished or damaged material. |

Storage & Handling

Be sure to store the material flat, keep it dry, safe & secure and remain in unopened cartons until ready to be installed. **See Appendix for proper handling and care instructions.**

Cleaning Recommendations

- Initial and periodic cleaning for best looking product
- Basic methods use a combination of moderate water pressure, soft sponge/brush and a mild detergent (Safe for your hands, safe for the product)

⚠ NEVER use aggressive acid or alkaline cleaners on Longboard finishes. Do not use cleaners containing Trisodium Phosphate, Phosphoric Acid, Hydrochloric Acid, Hydrofluoric Acid, Fluorides, or any other compound that is known to react with metal.

***See Cleaning Guide for full requirements & cleaning schedule:**
longboardproducts/resources/care-maintenance.com

Warranty

Upon substantial completion of the project, register for warranty online here: longboardproducts.com/warranty
 Registration is required for the warranty to be in effect.

- To be covered by warranty Castellations Planks shall be installed vertically, to limit standing water **as per Clause 4.4 of the Pinnacle Warranty Document**



Graffiti Removal

Standard Woodgrain 

Use Standard soap & water only

D2000 Solid Color

	Prosoco Cleaner	MEK Solvent
Permanent Marker	<input checked="" type="checkbox"/>	<input checked="" type="checkbox"/>
Oil Based Spray Paint	<input checked="" type="checkbox"/>	<input checked="" type="checkbox"/>
Water Based Spray Paint	<input checked="" type="checkbox"/>	<input checked="" type="checkbox"/>
Adhesive Tape	<input checked="" type="checkbox"/>	<input checked="" type="checkbox"/>

 MEK Solvent
 Prosoco Anti-Graffiti Cleaner

SPECIAL ORDER - EXT. LEAD TIMES CONTACT LB

Anti-Graffiti High Gloss Woodgrain

	MEK Solvent
Permanent Marker	<input checked="" type="checkbox"/>
Oil Based Spray Paint	<input checked="" type="checkbox"/>
Water Based Spray Paint	<input checked="" type="checkbox"/>
Adhesive Tape	<input checked="" type="checkbox"/>

 MEK Solvent

Note: Cleaning the surface with a cleanser that is not diluted as per instructions may result in damage to the coating.

Components

Components (Typical)

Textured Wall planks are used in conjunction with T&G components. For all LB components go to longboardproducts.com.

Castellation Planks

Size	12' *	24' *	12' Perf *	24' Perf *
4"	4CA.145	4CA.289	-	-
8"	8CA.145	8CA.289	-	-

Accessories

Product	Qty	SKU
Quick Screen Clips	1750, box	CLIP.N1750
Quick Screen Clips	100, bag	CLIP.N100
1/16" U-SHIM	250, bag	SHIM.1001
Butt-Joint Fastening Kit (6")	20 kits, bag	TGBJKIT
Touch Up Pens <i>Reach out to confirm color with account manager.</i>	N/A	TUP

Trim Components

Type	Style	Product	Dimensions	SKU
Starter	Precision	Starter J-Track	(5/8") - 12'	1SJT.145
Starter	Traditional	Starter Strip	(1-7/8") - 12'	2SS.145
Starter	Traditional	Back-to-Back Starter Strip	(1-1/4")	2BTBSS.145
J-Track	Precision	Two Piece J-Track	(5/8") - 12'	1X1JT.145
J-Track	Precision	J-Track	(5/8") - 12'	1JT.145
J-Track	Craftsman	J-Track	(7/8") - 12'	JT23.145
J-Track	Craftsman	Two Piece J-Track	(7/8") - 12'	JT23S.145
J-Track	Traditional	Two Piece J-Track	(1-3/8") - 12'	1X2JT.145
Corner	Precision	Outside Corner	(3/16") - 12'	05OC.145
Corner	Craftsman	Inside Corner	(3/4") - 12'	1IC.145
Corner	Craftsman	Outside Corner	(1") - 12'	1OC.145
Corner	Traditional	Corner Set	(2") - 12'	2CORS.145
Corner	Traditional	3" Smooth	(3") - 24'	3SCP.289
Corner	Traditional	3" V-Groove	(3") - 24'	3SVP.289
Reveal	Precision	Flat Reveal	(1/2") - 12'	1FR.145
Reveal	Precision	T&G Flat Reveal	(1/2") - 24'	1TGFR.289
Reveal	Craftsman	U-Reveal Set	(3/4") - 12'	1URS.145
Reveal	Craftsman	T&G U-Reveal	(3/4") - 24'	1TGURK.289
Reveal	Traditional	U-Reveal Set	(1-1/2") - 12'	2URS.145
Reveal	Traditional	Flat Reveal Set	(1-1/2") - 12'	2FRS.145
Reveal	Traditional	T&G U-Reveal	(1-1/2") - 24'	2TGURK.289
Reveal	Traditional	Offset Flat Reveal Set, J-Track Base	(2") - 12'	2OFFJ.145
Reveal	Traditional	Offset Flat Reveal Set, Termination Base	(2") - 12'	2OFFT.145
Termination	Precision	Termination Set	(5/8") - 12'	1TS.145
Termination	Craftsman	Termination Set	(7/8") - 12'	TS23S.145
Termination	Traditional	Termination Set	(1-3/8") - 12'	2TS.145
Compression Joints	Traditional	Compression Joint	(1-3/8") - 24'	2CJ.289

Castellation Planks

Woodgrains:
Link & Lock™ Required



Solid Colors:
Link & Lock™ NOT Required

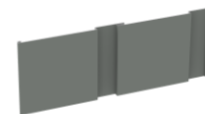

Butt-Joint
Fastening Kit





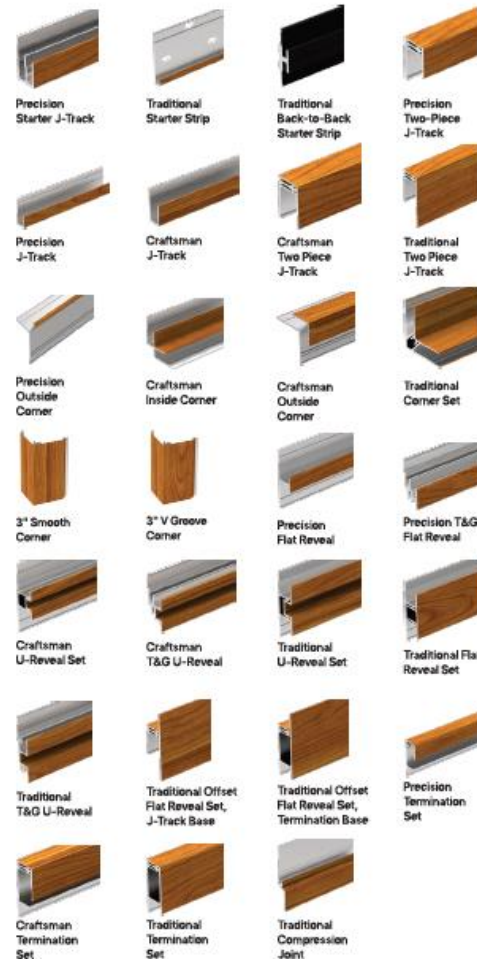



U-Shim

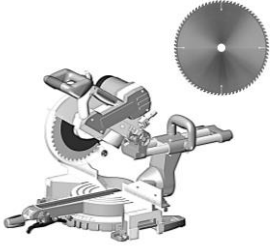

Tools/Cutting/Fastening

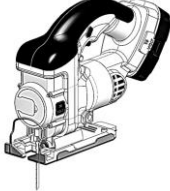
Tools

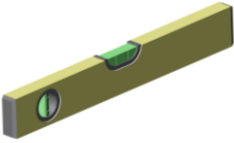
Commonly used tools for Cladding install.

			
Table Saw with Carbide Metal Blade Non-ferrous 60-80T (for cutting aluminum)	Miter Saw with Carbide Metal Blade Non-ferrous 60-80T (for cutting aluminum)	Cordless Drill with clutch	Jig Saw (for protrusions)
			
Rubber Mallet (or Hammer)	Level	Hole Saw (for lighting fixtures)	#10 Pan Head Screws (Supplied by others) <small>*Length, thread and point to suit substrate</small>

Cutting

⚠ Always be sure to wear appropriate PPE: eye & hearing protection.

Cut planks using a Miter Saw and Table Saw, always allowing for expansion & contraction. Trim the taped/drilled ends of all stock length material by at least **1/2" (12mm) each end** and discard.

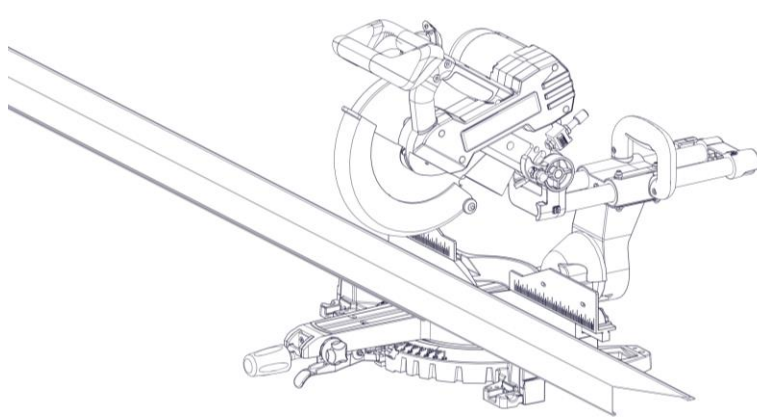

DO NOT Install Planks or Trims without trimming the ends.

Fastening

⚠ Always consult the project engineer, architect or authority having jurisdiction to understand the project specific fastening requirements.

Typical spacing:

-using **#10 Fasteners (by others)**

Trim components including Starter Strip

- **16" (406mm) O.C.**

Planks

Standard wind loads

- **32" (813mm) O.C.**

Higher wind loads

- **16" (406mm) O.C.**

See **Appendix for fastening specs:**

Fastening Castellations -Table 3

Fastening L&L -Table 4-7

Framing/Furring requirements

Always consult the local building authority and follow local building code requirements.

When attaching to **Hitch Cladding attachment System** refer to Hitch Install Guide for requirements.

See **Appendix for framing/furring/sheathing specs: Tables 3-7**

Fastener types

RECOMMENDED

CORRECT

Pan-Head



*Length, thread and point to suit substrate

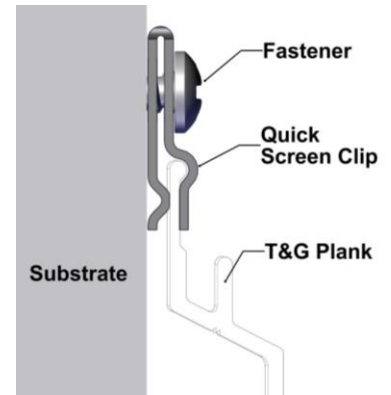

DO NOT USE

INCORRECT

Flat-Head

Oval-Head

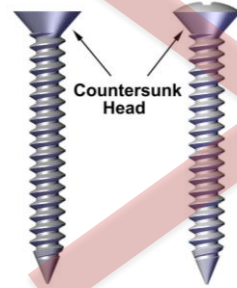

Countersunk Head

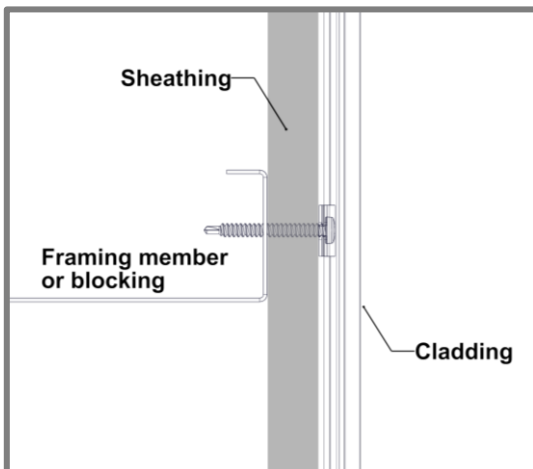
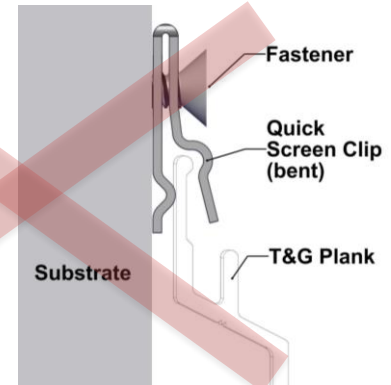

Fastening to Structure
(see Table 3-7 for specs)

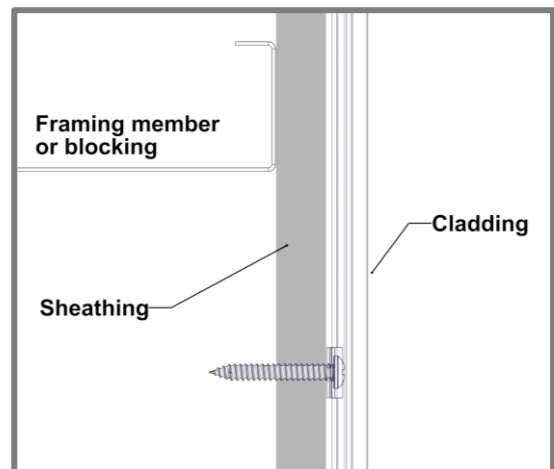

Fastening to Sheathing
(see Tables 3-7 for specs)

Fastening options onto exterior insulation or existing materials

*Never direct to insulation. Must be secured directly to solid secure substrate.

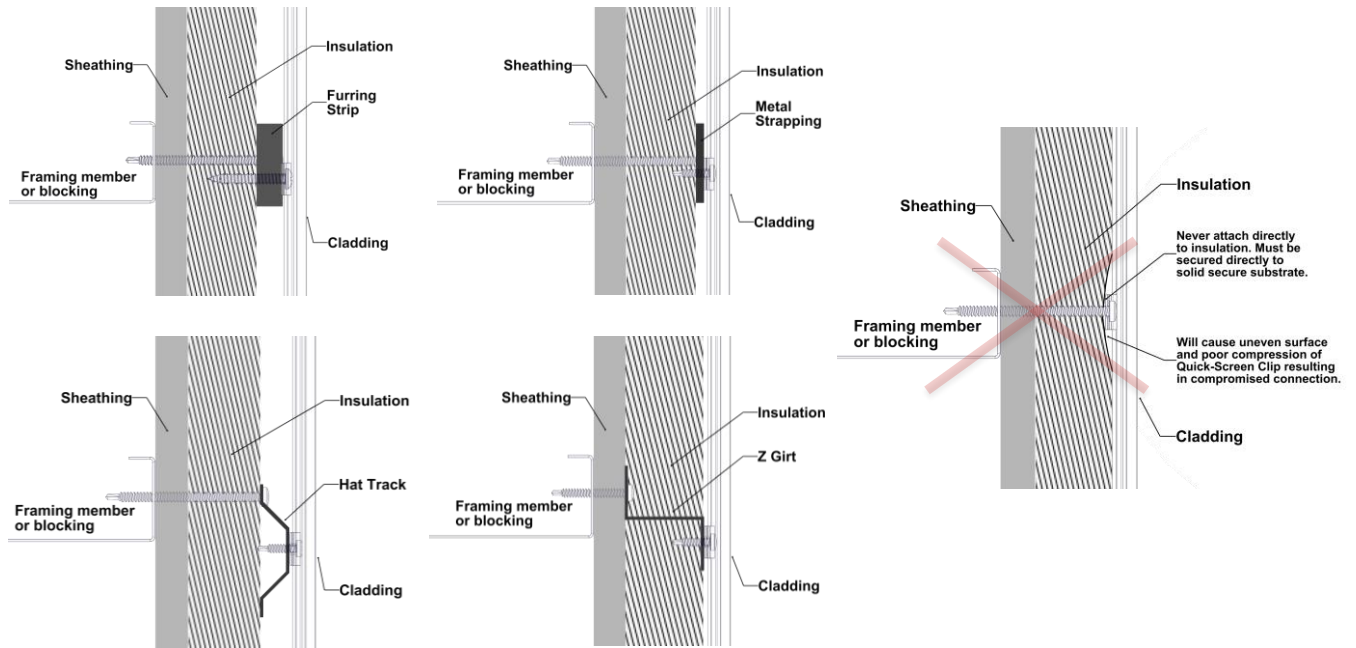

System Install

Perimeter and field area limitations

- Measure and layout your wall area to consider plank & component alignment with fixtures, penetrations, and adjacent walls, for desired appearance. Consider using butt-joints along runs to minimize waste. Apply the same methodology for horizontal Bevel Plank installations.
- To be covered by warranty Castellations Planks shall be installed vertically, to limit standing water **as per Clause 4.4 of the Pinnacle Warranty Document**

Seamless runs up to 24' length planks (no butt-joints).

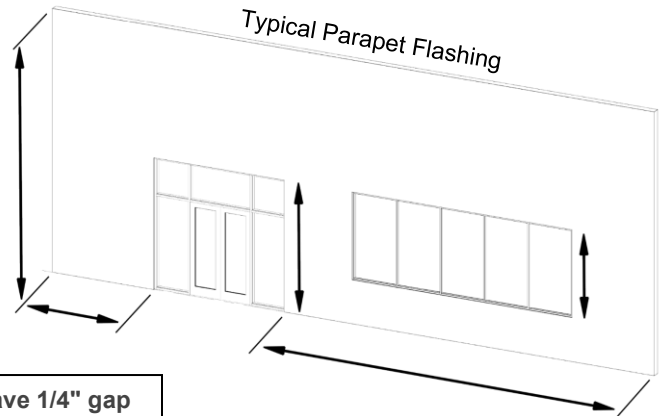
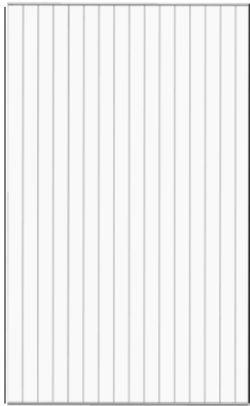

Note: Make sure to leave 1/4" gap at end of plank runs for expansion and contraction.

Runs up to 40' length with staggered butt-joints.

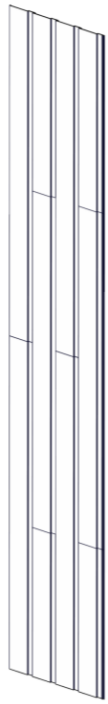

Castellation Planks -8" Castellationshown

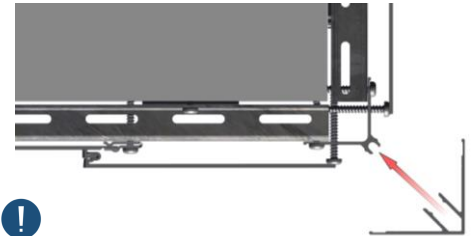
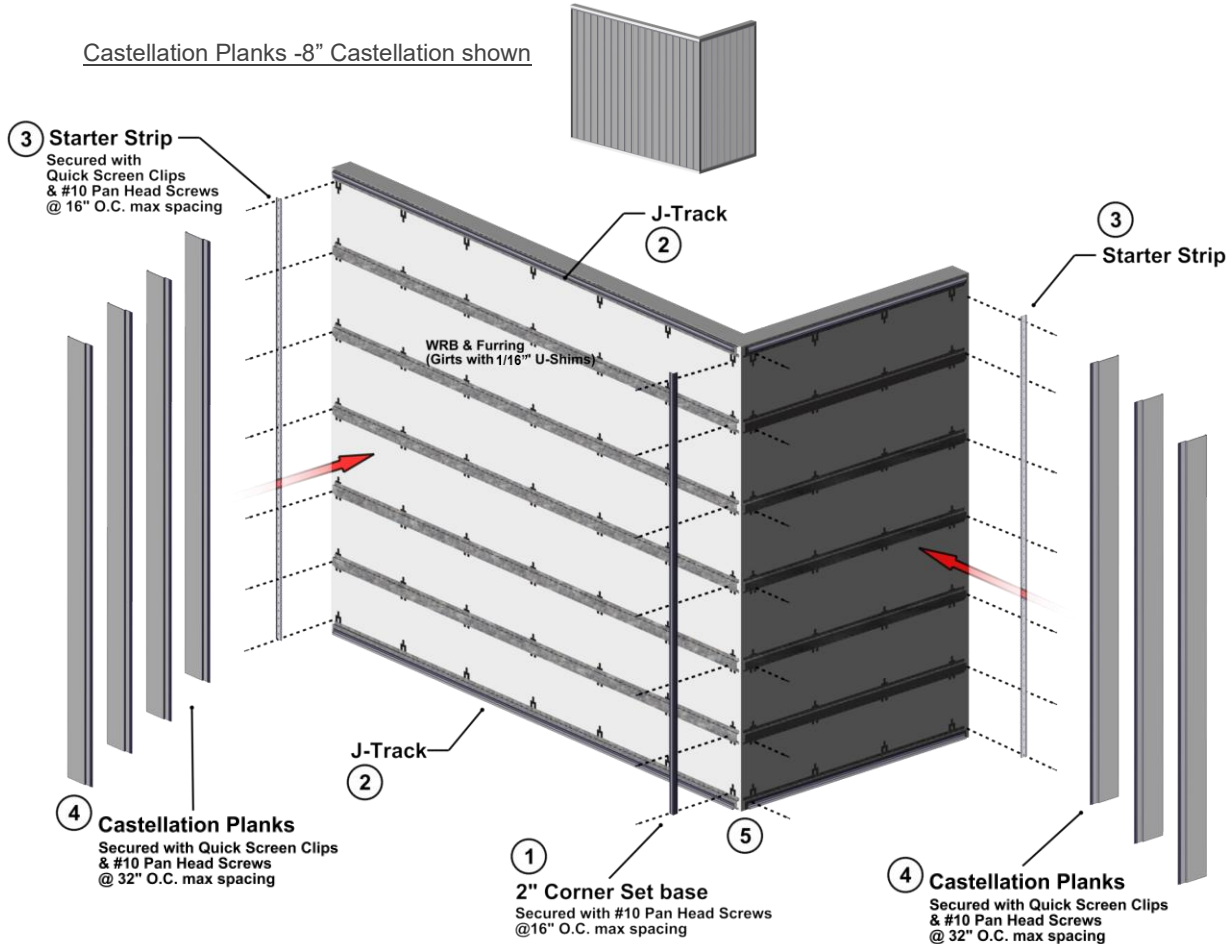

!
Confirm cut off
Taped/Drilled plank
ends (1/2" each end).

Step 1 & 2

Install 2" Corner Set base and J-Track (or Two Piece J-Track) with #10 Pan Head Screws @16" O.C. max spacing. Alternative starting option is to use Starter strip at the edge of the wall(s) fastening #10 Pan Head Screws every 16" O.C. max spacing.

Step 3

Install Starter Strip or Starter J-Track at the edge of walls using Quick Screen Clips & #10 Pan Head Screws @16" O.C. max spacing. Hard fasten only one point preferably near the center of each plank. See Appendix for Starter Strip loading.

Step 4 -See Page 12 if installing

Castellation planks with L&L. Place the planks fully engaging the tongue in the Starter. Fasten with Quick Screen Clips & #10 Pan Head Screws @32" O.C. max spacing. Hard fasten only one point near the center of each plank. It is good practice to check every 2-3 rows for level/plumb & flat or straight for best results. Ensure there is sufficient room for expansion & contraction of each Plank.

Step 5

When terminating confirm the trim component caps will cover the last Plank and adjust accordingly to suit the profile. Where terminating cut planks, provide a positive stop approximately every 16" (406mm).
When all Planks are installed finish off the trims with caps from two-piece sets.

Castellation Planks -with Link & Lock

Plank Install

To prepare Castellation Planks for Link & Lock install:



Step 1

Measure & cut the castellation plank to length and lay plank into place. Adjust for expansion & contraction and confirm that trim components cover the plank (fasten with screw to temporarily hold in place if needed).

Mark out the L&L attachment points at the castellation groove, remove and drill out the plank at these locations.

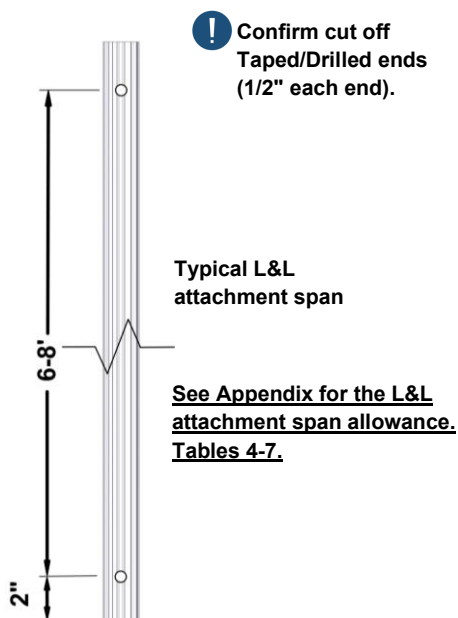

Step 2

Replace plank, center the holes at the attachment points and install with Quick Screen Clips, #10 Pan Head Screws and 1/16" Shims. The shims are used to support the L&L install at the attachment point. Purchased separately.

Repeat these steps for the rest of the Castellation Planks or mark and drill for the desired measurement.

Note: To hard fasten 1 location per length, omit the drilled hole at that location and hard fasten.

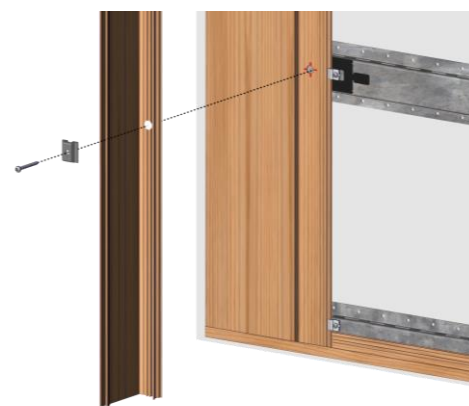

See next page for L&L install steps.

Castellation Planks -with Link & Lock

Link & Lock Install

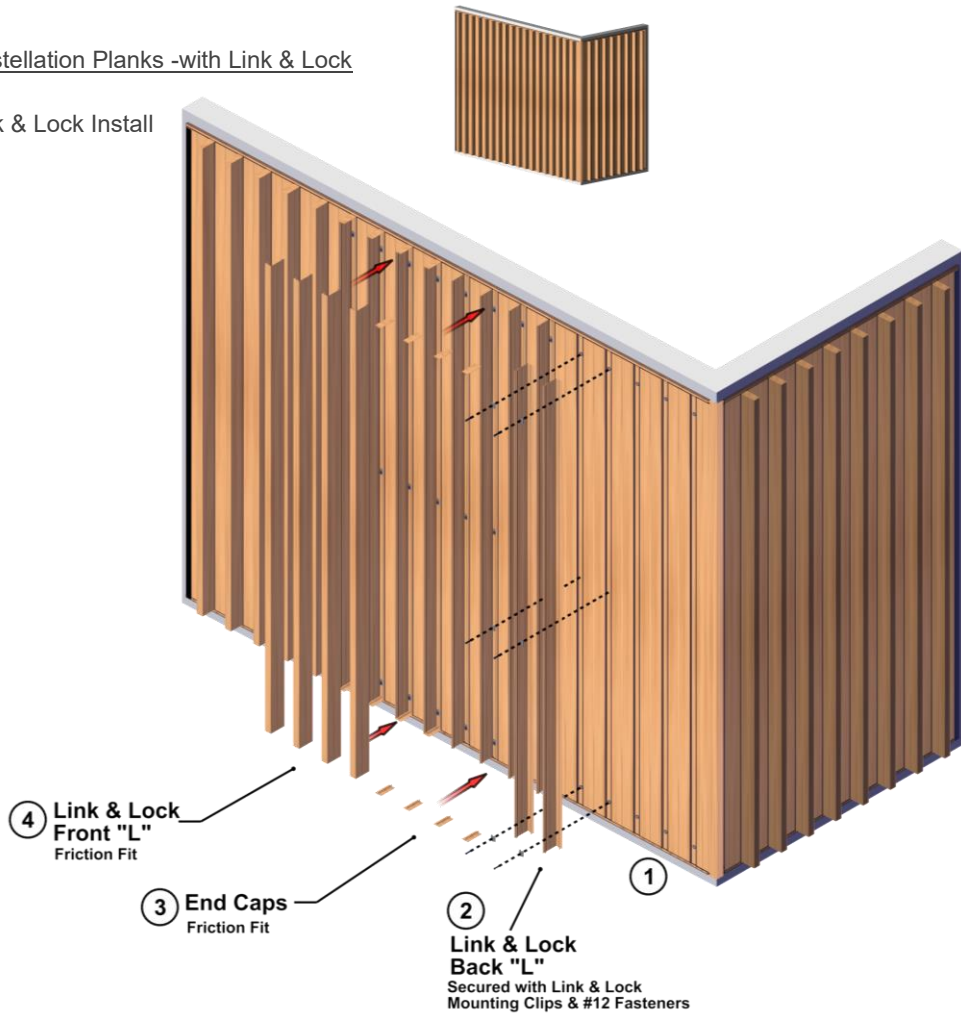

Step 1

Measure, mark and drill out the L&L back "L" for the 1/2" holes to match the Castellation planks.



Step 2

Secure the Back "L" to the Castellation Planks with Link & Lock Mounting Clip & #12 Fasteners. Make sure it aligns and fits into the groove correctly and is anchored into the center of the drilled-out holes. Leave gap for expansion & contraction and End Cap allowance.

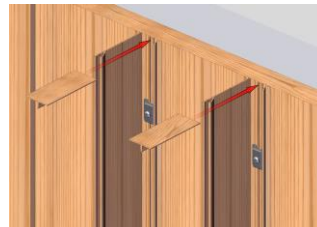

Step 3

Install End Caps top & bottom into Back "L" sliding them into the screw chase.

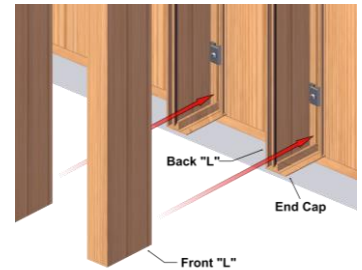

Step 4

Install Front "L" locking it into place. It is good practice to check components for a tight fit.

Details

Single Butt-Joints

- Consider using butt-joints along runs to minimize waste.
- When installing staggered butt-joints, use the Butt-Joint Fastening Kit to ensure joints do not open up **(See Detail A & B)**.
Fasteners should be placed at the uppermost location of the plank flange, to not interfere with the next plank engaging the tongue and groove properly. At the butt-joint, fasteners should be anchored into the Butt-Joint backer plate.
- **(See Detail C)**
- Rivets can be used for single butt-joints, however clearance of the rivets and room for movement is required.
- On exposed cuts such as butt-joints, trim ends or similar, use touch-up paint pens (purchased separately) to finish the ends of the two (2) planks at the butt-joint.
- DO NOT hard-fasten a plank to a component trim, as this will restrict its ability to expand & contract into the component.
- If no butt joints along the length, it is good practice to hard-fasten each plank directly through the flange near the center, to keep the planks from migrating.
- DO NOT hard-fasten more than one (1) location per plank.
- Hard fasten at the butt-joint or the center of each plank run.

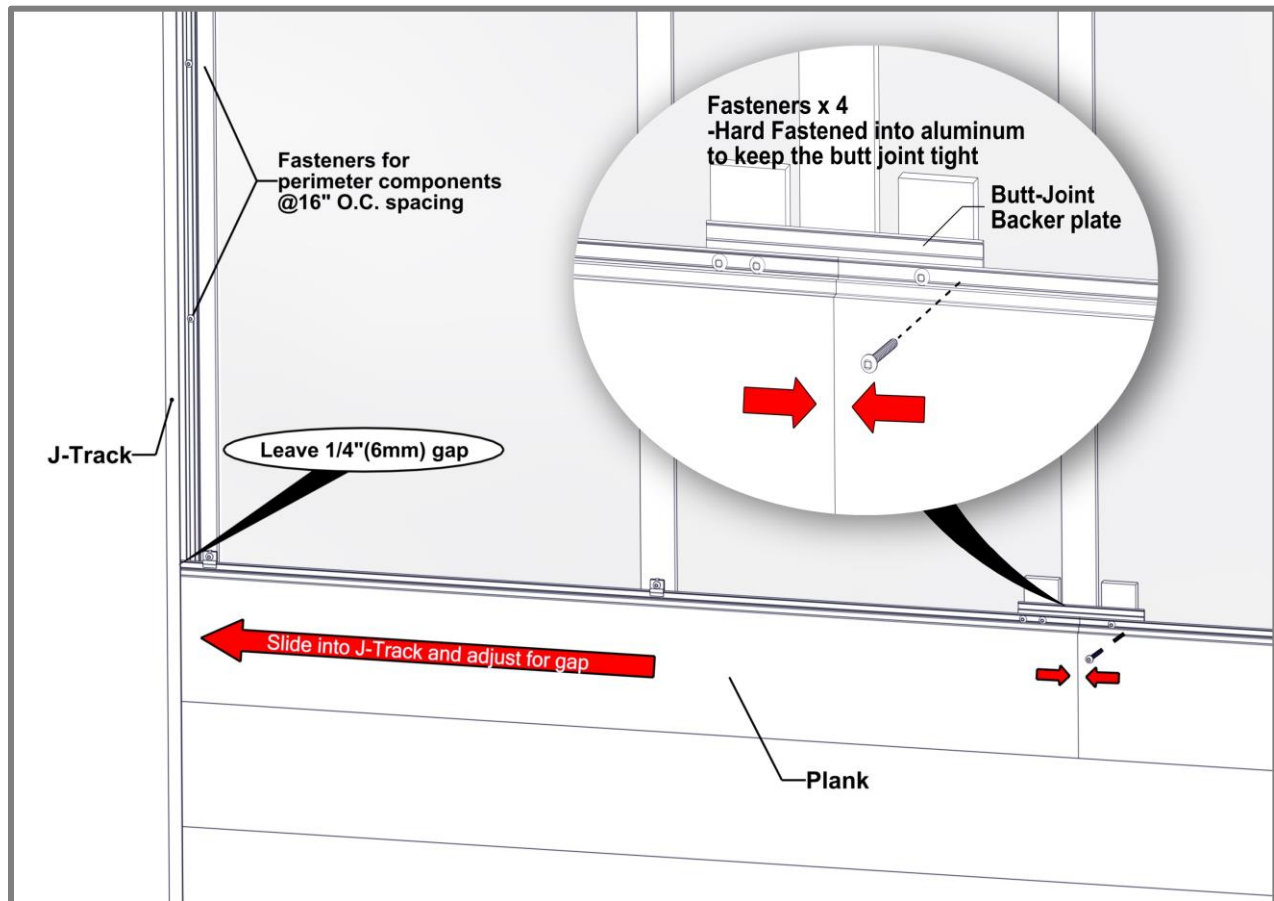

Detail A -Horizontal Cladding

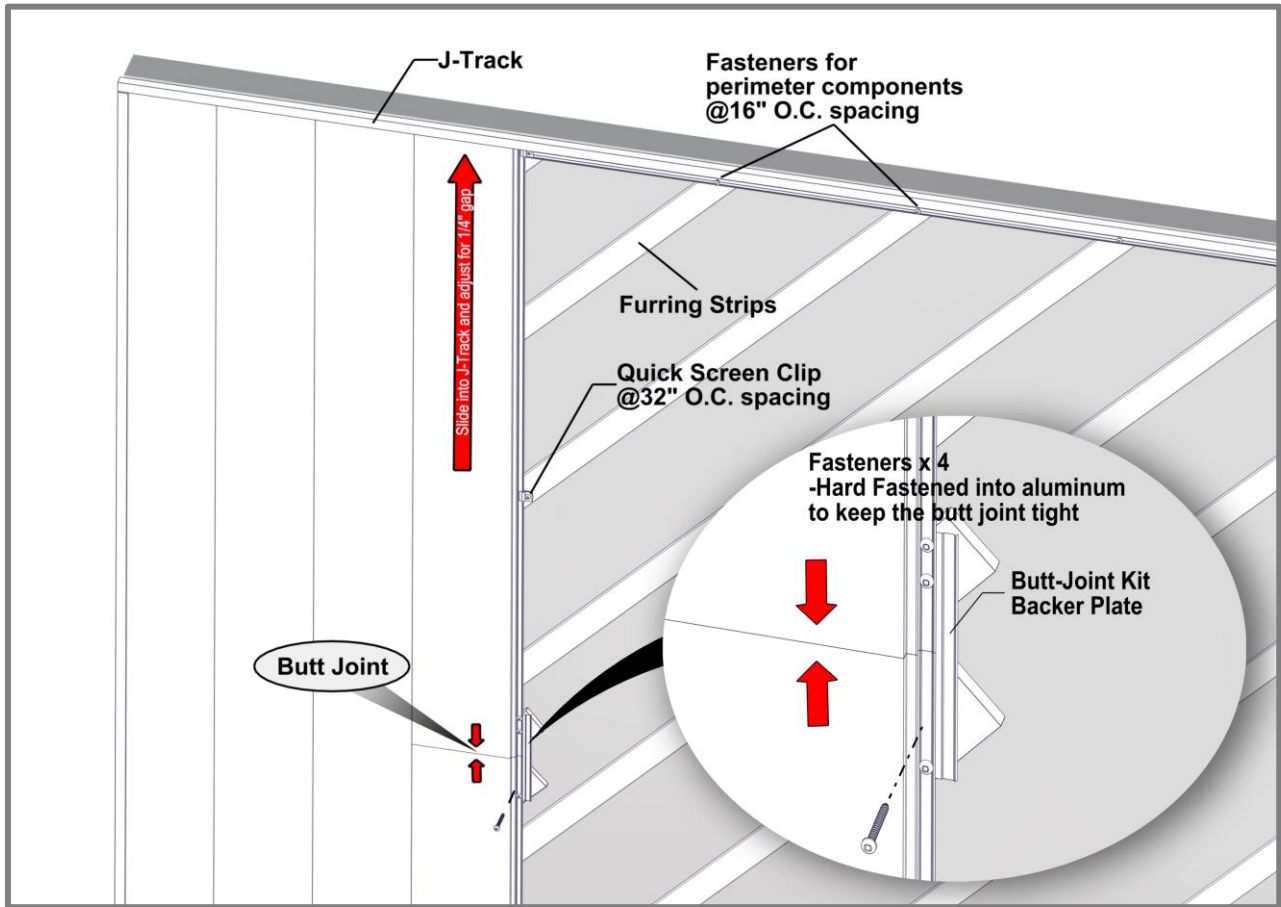

Detail B -Vertical Cladding

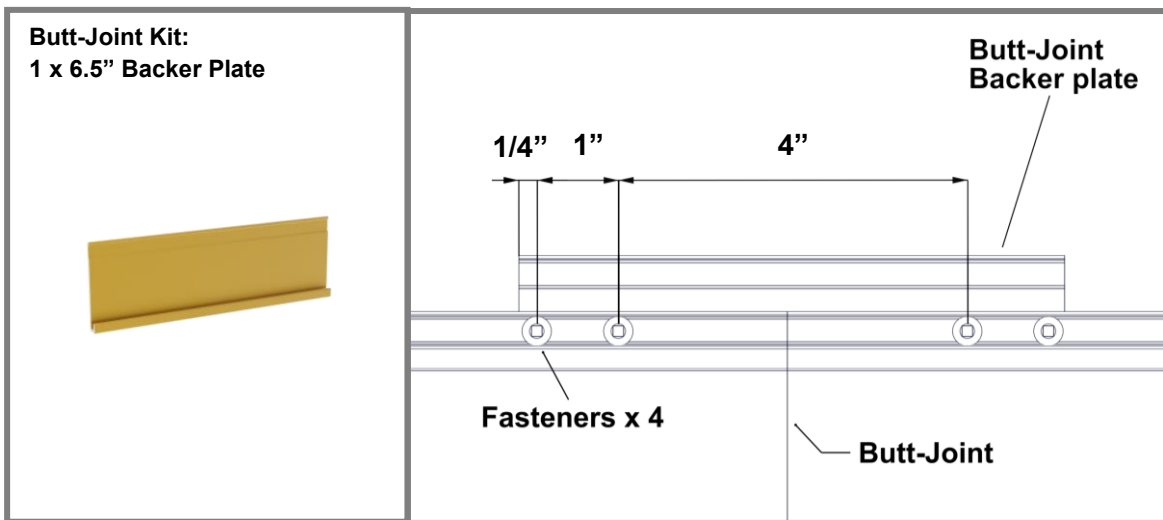

Detail C -Backer Plate (Hard Fastened)

Multiple Floating Butt-Joints

- When installing staggered multiple floating butt-joints, use the Butt-Joint Fastening Kit to ensure joints do not open up. Rivets should be placed at the center of the plank flange, to not interfere with the next plank engaging the tongue and groove properly. **(See Detail D)**
- **MUST HAVE** furring strips or girts to allow room for movement.
- Recommended to be installed between furring strips or framing members to avoid contact which would restrict movement. **(See Detail E)**
- On exposed cuts such as butt-joints, trim ends or similar, use touch-up paint pens (purchased separately) to finish the ends of the two (2) planks at the butt-joint.
- **DO NOT** hard-fasten a plank to a component trim, as this will restrict its ability to expand & contract into the component.
- **DO NOT** hard-fasten more than one (1) location per multiple plank run.
- Hard fasten near the center of the multiple plank run.

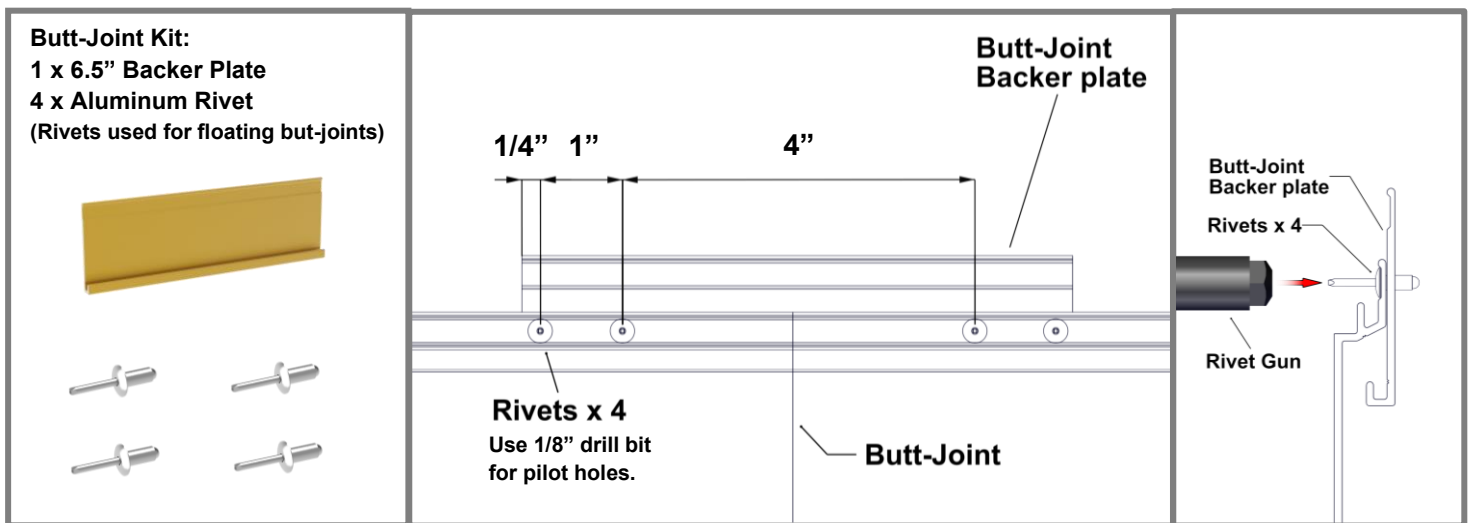

Detail D -Floating Butt-Joint

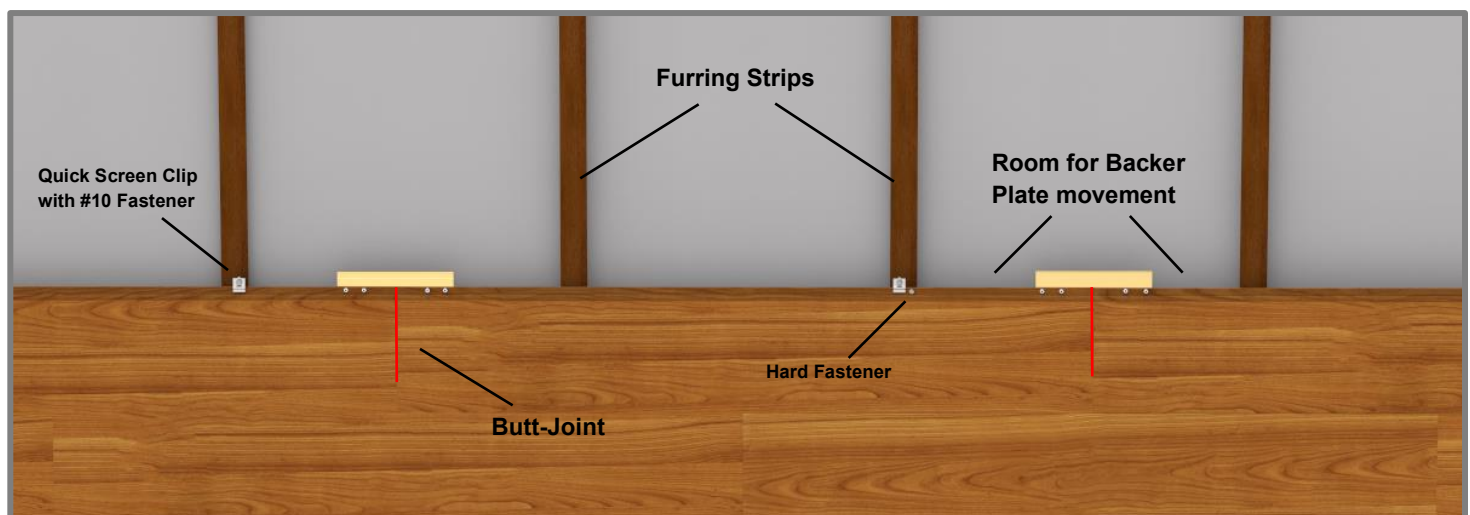

Detail E -Butt-Joint Movement

Appendix

Expansion and Contraction Tables

TABLE 1 - IMPERIAL

		AVERAGE TEMPERATURE AT TIME OF CUTTING & INSTALLATION											
		°C	-50	-40	-30	-20	-10	0	10	20	30	40	50
		°F	-58	-40	-22	-4	14	32	50	68	86	104	122
MIN/MAX POST CONSTRUCTION TEMP.	°C	°F	EXPANSION OR CONTRACTION (INCH/FOOT)										
	-50	-58	0.000	-0.003	-0.005	-0.008	-0.011	-0.014	-0.016	-0.019	-0.022	-0.024	-0.027
	-40	-40	0.003	0.000	-0.003	-0.005	-0.008	-0.011	-0.014	-0.016	-0.019	-0.022	-0.024
	-30	-22	0.005	0.003	0.000	-0.003	-0.005	-0.008	-0.011	-0.014	-0.016	-0.019	-0.022
	-20	-4	0.008	0.005	0.003	0.000	-0.003	-0.005	-0.008	-0.011	-0.014	-0.016	-0.019
	-10	14	0.011	0.008	0.005	0.003	0.000	-0.003	-0.005	-0.008	-0.011	-0.014	-0.016
	0	32	0.014	0.011	0.008	0.005	0.003	0.000	-0.003	-0.005	-0.008	-0.011	-0.014
	10	50	0.016	0.014	0.011	0.008	0.005	0.003	0.000	-0.003	-0.005	-0.008	-0.011
	20	68	0.019	0.016	0.014	0.011	0.008	0.005	0.003	0.000	-0.003	-0.005	-0.008
	30	86	0.022	0.019	0.016	0.014	0.011	0.008	0.005	0.003	0.000	-0.003	-0.005
	40	104	0.024	0.022	0.019	0.016	0.014	0.011	0.008	0.005	0.003	0.000	-0.003
	50	122	0.027	0.024	0.022	0.019	0.016	0.014	0.011	0.008	0.005	0.003	0.000

TABLE 2 - METRIC

		AVERAGE TEMPERATURE AT TIME OF CUTTING & INSTALLATION											
		°C	-50	-40	-30	-20	-10	0	10	20	30	40	50
		°F	-58	-40	-22	-4	14	32	50	68	86	104	122
MIN/MAX POST CONSTRUCTION TEMP.	°C	°F	EXPANSION OR CONTRACTION (MM/METER)										
	-50	-58	0.000	-0.230	-0.460	-0.690	-0.920	-1.150	-1.380	-1.610	-1.840	-2.070	-2.300
	-40	-40	0.230	0.000	-0.230	-0.460	-0.690	-0.920	-1.150	-1.380	-1.610	-1.840	-2.070
	-30	-22	0.460	0.230	0.000	-0.230	-0.460	-0.690	-0.920	-1.150	-1.380	-1.610	-1.840
	-20	-4	0.690	0.460	0.230	0.000	-0.230	-0.460	-0.690	-0.920	-1.150	-1.380	-1.610
	-10	14	0.920	0.690	0.460	0.230	0.000	-0.230	-0.460	-0.690	-0.920	-1.150	-1.380
	0	32	1.150	0.920	0.690	0.460	0.230	0.000	-0.230	-0.460	-0.690	-0.920	-1.150
	10	50	1.380	1.150	0.920	0.690	0.460	0.230	0.000	-0.230	-0.460	-0.690	-0.920
	20	68	1.610	1.380	1.150	0.920	0.690	0.460	0.230	0.000	-0.230	-0.460	-0.690
	30	86	1.840	1.610	1.380	1.150	0.920	0.690	0.460	0.230	0.000	-0.230	-0.460
	40	104	2.070	1.840	1.610	1.380	1.150	0.920	0.690	0.460	0.230	0.000	-0.230
	50	122	2.300	2.070	1.840	1.610	1.380	1.150	0.920	0.690	0.460	0.230	0.000

TABLE 3

CASTELLATION PLANKS		PSF (Factored / Ultimate)										
		20	30	40	50	60	70	80	90	100	110	120
QUICK-SCREEN CLIP SPACING (IN)	8"											
	12"							8" Castellations on CMU				
	16"							8" Castellations on CMU				
	24"											
	32"											
Plank Profiles: Castellations (4", 8")												
TRIM COMPONENTS*		PSF (Factored / Ultimate)										
		20	30	40	50	60	70	80	90	100	110	120
	16"											
Soffit direct to truss	24"											
*Starter Strip requires Two (2) installation anchors at each fastener location: 1 Quick-Screen Clip + 1 Mid-Point slotted hole												
<i>Calculations are using L/180 deflection limits</i>												
SUBSTRATE TYPE	SUBSTRATE REQUIREMENTS	ANCHOR DESCRIPTION		MIN. EMBEDMENT	MIN. EDGE DISTANCE							
WOOD	Min. specific gravity = 0.55 wood	#10 Pan Head Screw		1-1/2"	1/2"							
PLYWOOD	Min. 5/8" C/D Grade Plywood			1/4" past plywood structure	1"							
STEEL	Min. 18 ga., min. 33 ksi.	#10 Tek Screw (grade 5)		3 threads penetration past metal structure								
ALUMINUM	Min. 1/8" thick, min. 6063-T5											
CONCRETE**	Min. 3000 psi	3/16" ITW Tapcon		1"	1-7/8"							
MASONRY - CMU**	Grout-filled block per ASTM C-90, min. 2000 psi			1"	2"							
**For Concrete and Masonry/CMU; Furring Strips are recommended, where possible												
GENERAL NOTES:												
1. Adequacy of the structural stud framing (wood and/or metal) and concrete/masonry as a main wind force resisting system capable of withstanding and transferring applied product loads to the foundation is the responsibility of the engineer or architect of record for the project of installation.												
2. Substrate shall be designed and anchored to properly transfer all loads to the structure buck design and installation is the responsibility of the engineer or architect of record for the project of installation.												
3. The installation details described herein are generic and may not reflect actual conditions for a specific site. If site conditions cause installation to deviate from the requirements detailed herein, a licensed engineer or architect shall prepare site specific documents for use with this document.												
INSTALLATION NOTES:												
1. One (1) installation anchor is required at each Quick-Screen Clip location. Minimum of two (2) anchors per plank.												
2. Spacing is from clip/fastener center to center.												
3. The number of installation anchors per the table is the minimum number of anchors to be used for product installation.												
4. Install individual installation anchors within a tolerance of +/- 1/2" of the specified spacings. Tolerances are not cumulative from one installation anchor to the next.												
5. If fastening to every second stud, the attachment stud shall be staggered between adjacent runs of cladding.												
6. Minimum embedment and edge distance exclude wall finishes, including but not limited to wood furrings, stucco, foam, brick veneer, sheathing and siding.												
7. Installation anchors and associated hardware must be made of corrosion resistant material or have a corrosion resistant coating. Common fastener types can be equal or better to a & b listed below:												
a. Zinc plated fasteners for moderate climate zones												
b. 316 Stainless Steel fasteners for coastal climate zones												
8. For CMU grout filled block, do not install installation anchors into mortar joints. Edge distance is measured from free edge of block or edge of mortar joint into face shell of block.												
9. Installation anchors shall be installed in accordance with anchor manufacturer's installation instructions, and anchors shall not be used in substrates with strengths less than the minimum strength specified by the anchor manufacturer.												

TABLE 4

LONGBOARD® INSPIRING ARCHITECTURE		FASTENER SPACING - LOAD TABLE										v1.1
		PSF (Factored / Ultimate)										
2" LINK & LOCK™		20	30	40	50	60	70	80	90	100	110	120
Standard												
ALLOWABLE SPAN (FT)*	4'											
	6'											
	8'											
	10'											
*CANTILEVERS are not to exceed half (1/2) the allowable span to a maximum of 3'												
<i>Calculations are using L/180 deflection limits</i>												
SUBSTRATE TYPE	SUBSTRATE REQUIREMENTS		ANCHOR DESCRIPTION		MIN. EMBEDMENT		MIN. EDGE DISTANCE					
WOOD	Min. specific gravity = 0.55 wood		#12 Pan Head Wood Screw		1-1/2"		1"					
STEEL	Min. 18 ga., Min. Fy=33 ksi.		#12 Self-Drilling or Self-Tapping Screw (Grade 5)		3 threads penetration past metal structure		1/2"					
ALUMINUM	Min. 1/8", Min. 8063-T5		3/16" ITW Tapcon		1-1/2"		1-3/4"					
CONCRETE	Min. 3000 psi				1"		2"					
HOLLOWGROUT-FILLED CMU	Conforms to ASTM C-90, with Min. compressive strength of 2000 psi											

GENERAL NOTES:

- This product has been designed and manufactured to comply with the current Florida Building Code (FBC), **INCLUDING** HVHZ and has been evaluated according to the following:
 - Section 1709.8
 - ASTM E8-16
- Adequacy of the structural concrete/masonry and 2X framing as a main wind force resisting system capable of withstanding and transferring applied product loads to the foundation is the responsibility of the engineer or architect of record for the project of installation.
- Substrate shall be designed and anchored to properly transfer all loads to the structure. Buck design and installation is the responsibility of the engineer or architect of record for the project of installation.
- The installation details described herein are generic and may not reflect actual conditions for a specific site. If site conditions cause installation to deviate from the requirements detailed herein, a licensed engineer or architect shall prepare site specific documents for use with this document.
- Link & Lock is not designed to be a life-safety item. Designs of this nature are the responsibility of the engineer or architect of record.

INSTALLATION NOTES:

- One (1) installation anchor is required at each location. Minimum of two (2) anchors per batten.
- Spacing is from fastener center to center.
- The number of installation anchors per the table is the minimum number of anchors to be used for product installation.
- Install individual installation anchors within a tolerance of +/- 1/2" of the specified spacings. Tolerances are not cumulative from one installation anchor to the next.
- Minimum embedment and edge distance exclude wall finishes, including but not limited to stucco, foam, brick veneer, sheathing and siding.
- Installation anchors and associated hardware must be made of corrosion resistant material or have a corrosion resistant coating. Common fastener types can be equal or better to a & b listed below.
 - Zinc plated fasteners for moderate climate zones
 - 316 Stainless Steel fasteners for coastal climate zones
- For hollow block and grout filled CMU block, do not install installation anchors into mortar joints. Edge distance is measured from free edge of block or edge of mortar joint into face shell of block.
- Installation anchors shall be installed in accordance with anchor manufacturer's installation instructions, and anchors shall not be used in substrates with strengths less than the minimum strength specified by the anchor manufacturer.
- When using end mounts, span distance is measured center to center of each end mount.

TABLE 5

4" LINK & LOCK™			FASTENER SPACING - LOAD TABLE										
			PSF (Factored / Ultimate)										
Standard	Standard w. Stiffener	HD	20	30	40	50	60	70	80	90	100	110	120
ALLOWABLE SPAN (FT)*	2'												
	4'								Standard w. Stiffener				
	6'							Standard w. Stiffener		HD			
	8'				Standard w. Stiffener			HD					
	10'		Standard w. Stiffener			HD							
	12'		Standard w. Stiffener		HD								

*CANTILEVERS are not to exceed half (1/2) the allowable span to a maximum of 3'

Calculations are using L/180 deflection limits

SUBSTRATE TYPE	SUBSTRATE REQUIREMENTS	ANCHOR DESCRIPTION	MIN. EMBEDMENT	MIN. EDGE DISTANCE
WOOD	Min. specific gravity = 0.55 wood	#12 Pan Head Wood Screw	1-1/2"	1"
STEEL	Min. 18 ga., Min. Fy=33 ksi.	#12 Self-Drilling or Self-Tapping Screw (Grade 5)	3 threads penetration past metal structure	1/2"
ALUMINUM	Min. 1/8", Min. 6063-T5			
CONCRETE	Min. 3000 psi	3/16" ITW Tapcon	1-1/2"	1-3/4"
HOLLOW/GROUT-FILLED CMU	Conforms to ASTM C-90, with Min. compressive strength of 2000 psi		1"	2"

GENERAL NOTES:

- This product has been designed and manufactured to comply with the current Florida Building Code (FBC), **INCLUDING** HVHZ and has been evaluated according to the following:
 - Section 1709.8
 - ASTM E8-16
- Adequacy of the structural concrete/masonry and 2X framing as a main wind force resisting system capable of withstanding and transferring applied product loads to the foundation is the responsibility of the engineer or architect of record for the project of installation.
- Substrate shall be designed and anchored to properly transfer all loads to the structure. Buck design and installation is the responsibility of the engineer or architect of record for the project of installation.
- The installation details described herein are generic and may not reflect actual conditions for a specific site. If site conditions cause installation to deviate from the requirements detailed herein, a licensed engineer or architect shall prepare site specific documents for use with this document.
- Link & Lock is not designed to be a life-safety item. Designs of this nature are the responsibility of the engineer or architect of record.

INSTALLATION NOTES:

- One (1) installation anchor is required at each location. Minimum of two (2) anchors per batten.
- Spacing is from fastener center to center.
- The number of installation anchors per the table is the minimum number of anchors to be used for product installation.
- Install individual installation anchors within a tolerance of +/- 1/2" of the specified spacings. Tolerances are not cumulative from one installation anchor to the next.
- Minimum embedment and edge distance exclude wall finishes, including but not limited to stucco, foam, brick veneer, sheathing and siding.
- Installation anchors and associated hardware must be made of corrosion resistant material or have a corrosion resistant coating. Common fastener types can be equal or better to a & b listed below:
 - Zinc plated fasteners for moderate climate zones
 - 316 Stainless Steel fasteners for coastal climate zones
- For hollow block and grout filled CMU block, do not install installation anchors into mortar joints. Edge distance is measured from free edge of block or edge of mortar joint into face shell of block.
- Installation anchors shall be installed in accordance with anchor manufacturer's installation instructions, and anchors shall not be used in substrates with strengths less than the minimum strength specified by the anchor manufacturer.
- When using end mounts, span distance is measured center to center of each end mount.

TABLE 6

6" LINK & LOCK™			FASTENER SPACING - LOAD TABLE												
			PSF (Factored / Ultimate)												
Standard	Standard w. Stiffener	HD	20	30	40	50	60	70	80	90	100	110	120		
ALLOWABLE SPAN (FT)*			2'												
			4'											Standard w. Stiffener	
			6'				Standard w. Stiffener	HD							
			8'	Standard w. Stiffener			HD								
			10'	Standard w. Stiffener			HD								
			12'	HD											

*CANTILEVERS are not to exceed half (1/2) the allowable span to a maximum of 3'

Calculations are using L/180 deflection limits

SUBSTRATE TYPE	SUBSTRATE REQUIREMENTS	ANCHOR DESCRIPTION	MIN. EMBEDMENT	MIN. EDGE DISTANCE
WOOD	Min. specific gravity = 0.55 wood	#12 Pan Head Wood Screw	1-1/2"	1"
STEEL	Min. 18 ga., Min. Fy=33 ksi.	#12 Self-Drilling or Self-Tapping Screw (Grade 5)	3 threads penetration past metal structure	1/2"
ALUMINUM	Min. 1/8", Min. 6063-T5			
CONCRETE	Min. 3000 psi	3/16" ITW Tapcon	1-1/2"	1-3/4"
HOLLOW/GROUT-FILLED CMU	Conforms to ASTM C-90, with Min. compressive strength of 2000 psi		1"	2"

GENERAL NOTES:

- This product has been designed and manufactured to comply with the current Florida Building Code (FBC), **INCLUDING** HVHZ and has been evaluated according to the following:
 - Section 1709.8
 - ASTM E8-16
- Adequacy of the structural concrete/masonry and 2X framing as a main wind force resisting system capable of withstanding and transferring applied product loads to the foundation is the responsibility of the engineer or architect of record for the project of installation.
- Substrate shall be designed and anchored to properly transfer all loads to the structure. Buck design and installation is the responsibility of the engineer or architect of record for the project of installation.
- The installation details described herein are generic and may not reflect actual conditions for a specific site. If site conditions cause installation to deviate from the requirements detailed herein, a licensed engineer or architect shall prepare site specific documents for use with this document.
- Link & Lock is not designed to be a life-safety item. Designs of this nature are the responsibility of the engineer or architect of record.

INSTALLATION NOTES:

- One (1) installation anchor is required at each location. Minimum of two (2) anchors per batten.
- Spacing is from fastener center to center.
- The number of installation anchors per the table is the minimum number of anchors to be used for product installation.
- Install individual installation anchors within a tolerance of +/- 1/2" of the specified spacings. Tolerances are not cumulative from one installation anchor to the next.
- Minimum embedment and edge distance exclude wall finishes, including but not limited to stucco, foam, brick veneer, sheathing and siding.
- Installation anchors and associated hardware must be made of corrosion resistant material or have a corrosion resistant coating. Common fastener types can be equal or better to a & b listed below:
 - Zinc plated fasteners for moderate climate zones
 - 316 Stainless Steel fasteners for coastal climate zones
- For hollow block and grout filled CMU block, do not install installation anchors into mortar joints. Edge distance is measured from free edge of block or edge of mortar joint into face shell of block.
- Installation anchors shall be installed in accordance with anchor manufacturer's installation instructions, and anchors shall not be used in substrates with strengths less than the minimum strength specified by the anchor manufacturer.
- When using end mounts, span distance is measured center to center of each end mount.

TABLE 7

			FASTENER SPACING - LOAD TABLE											v1.1
8" LINK & LOCK™			PSF (Factored / Ultimate)											
Standard	Standard w. Stiffener	HD	20	30	40	50	60	70	80	90	100	110	120	
ALLOWABLE SPAN (FT)*			2'											
			4'					Standard w. Stiffener						HD
			6'			Standard w. Stiffener	HD							
			8'	Standard w. Stiffener	HD									
			10'	HD										

*CANTILEVERS are not to exceed half (1/2) the allowable span to a maximum of 3'

Calculations are using L/180 deflection limits

SUBSTRATE TYPE	SUBSTRATE REQUIREMENTS	ANCHOR DESCRIPTION	MIN. EMBEDMENT	MIN. EDGE DISTANCE
WOOD	Min. specific gravity = 0.55 wood	#12 Pan Head Wood Screw	1-1/2"	1"
STEEL	Min. 18 ga., Min. Fy=33 ksi.	#12 Self-Drilling or Self-Tapping Screw (Grade 5)	3 threads penetration past metal structure	1/2"
ALUMINUM	Min. 1/8", Min. 6063-T5			
CONCRETE	Min. 3000 psi	3/16" ITW Tapcon	1-1/2"	1-3/4"
HOLLOW/GROUT-FILLED CMU	Conforms to ASTM C-90, with Min. compressive strength of 2000 psi		1"	2"

GENERAL NOTES:

- This product has been designed and manufactured to comply with the current Florida Building Code (FBC), **INCLUDING** HVHZ and has been evaluated according to the following:
 - Section 1709.8
 - ASTM E8-16
- Adequacy of the structural concrete/masonry and 2X framing as a main wind force resisting system capable of withstanding and transferring applied product loads to the foundation is the responsibility of the engineer or architect of record for the project of installation.
- Substrate shall be designed and anchored to properly transfer all loads to the structure. Buck design and installation is the responsibility of the engineer or architect of record for the project of installation.
- The installation details described herein are generic and may not reflect actual conditions for a specific site. If site conditions cause installation to deviate from the requirements detailed herein, a licensed engineer or architect shall prepare site specific documents for use with this document.
- Link & Lock is not designed to be a life-safety item. Designs of this nature are the responsibility of the engineer or architect of record.

INSTALLATION NOTES:

- One (1) installation anchor is required at each location. Minimum of two (2) anchors per batten.
- Spacing is from fastener center to center.
- The number of installation anchors per the table is the minimum number of anchors to be used for product installation.
- Install individual installation anchors within a tolerance of +/- 1/2" of the specified spacings. Tolerances are not cumulative from one installation anchor to the next.
- Minimum embedment and edge distance exclude wall finishes, including but not limited to stucco, foam, brick veneer, sheathing and siding.
- Installation anchors and associated hardware must be made of corrosion resistant material or have a corrosion resistant coating. Common fastener types can be equal or better to a & b listed below:
 - Zinc plated fasteners for moderate climate zones
 - 316 Stainless Steel fasteners for coastal climate zones
- For hollow block and grout filled CMU block, do not install installation anchors into mortar joints. Edge distance is measured from free edge of block or edge of mortar joint into face shell of block.
- Installation anchors shall be installed in accordance with anchor manufacturer's installation instructions, and anchors shall not be used in substrates with strengths less than the minimum strength specified by the anchor manufacturer.
- When using end mounts, span distance is measured center to center of each end mount.

Radius Table				
APPLICATION	A -Circular	B -Curved walls	C -Convex	D -Concave
DIAGRAMS		Termination Set *Starter	J-Track 	J-Track
TRIMS	Minimum Radius			
Non-Tempered Precision J-Track (5/8")	1.5' (0.46m)	N/A	1.5' (0.46m)	2' (0.61m)
Precision J-Track (5/8")	15' (4.57m)	N/A	N/A	N/A
Precision Two-Piece J-Track w. J-base (5/8")	15' (4.57m)	N/A	8' (2.44m)	8' (2.44m)
Precision Termination Set (5/8")	N/A	12' (4.57m)	N/A	N/A
Non-Tempered Craftsman J-Track (7/8")	6' (1.83m)	N/A	6' (1.83m)	6' (1.83m)
Craftsman J-Track (7/8")	38' (11.6m)	N/A	20' (6.1m)	20' (6.1m)
Craftsman Two-Piece J-Track w. J-Base (7/8")	20' (6.1m)	N/A	8' (2.44m)	8' (2.44m)
Craftsman Termination Set (7/8")	N/A	12' (4.57m)	N/A	N/A
Non-Tempered Traditional J-Track (1-3/8")	38' (11.6m)	N/A	20' (6.1m)	20' (6.1m)
Traditional J-Track (1-3/8")	Not recommended	Not recommended	Not recommended	Not recommended
Traditional Two-Piece J-Track w. J-base (1-3/8")	38' (11.6m)	N/A	8' (2.44m)	8' (2.44m)
Traditional Termination Set (1-3/8")	N/A	12' (4.57m)	N/A	N/A
PLANKS	Minimum Radius			
2 1/2" V-Groove	N/A	12' (4.57m)	1.5' (0.46m)	2' (0.61m)
2 1/2" V-Groove Perforated	N/A	12' (4.57m)	1.5' (0.46m)	2' (0.61m)
4" V-Groove	N/A	12' (4.57m)	3' (0.91m)	6' (1.83m)
6" V-Groove	N/A	12' (4.57m)	3' (0.91m)	6' (1.83m)
6" Channel	N/A	12' (4.57m)	3' (0.91m)	6' (1.83m)
6" Smooth Plank	N/A	12' (4.57m)	3' (0.91m)	6' (1.83m)
6" V-Groove Perforated	N/A	12' (4.57m)	3' (0.91m)	6' (1.83m)
6" Smooth Plank Perforated	N/A	12' (4.57m)	3' (0.91m)	6' (1.83m)
4" Castellated	N/A	12' (4.57m)	3' (0.91m)	6' (1.83m)
8" Castellated	N/A	12' (4.57m)		
6" Triple Bevel	N/A	19' (5.8m)	3' (0.91m)	6' (1.83m)
8" V-Groove	N/A	12' (4.57m)		
<p>Note 1: When considering tight radii bends, use Non-Tempered Trim components for the minimum radius.</p> <p>Note 2: When bending and securing components, bend against solid secure object and take care not to over bend.</p> <p>*Note 3: Starter Strip meets or exceeds the performance of all the listed application and limitations.</p>				

Proper Handling of Longboard Products



To help avoid injury and product damage, Longboard products require proper handling to and from storage areas during installation. When carrying or installing any products it is recommended that they be moved or carried by at least two people with each support point approximately 4ft from the ends. **Carrying products without proper support can cause excessive bending which may damage the appearance or finish of the product.** Any short cut lengths should also be carried on edge while supporting the material. See below for details.

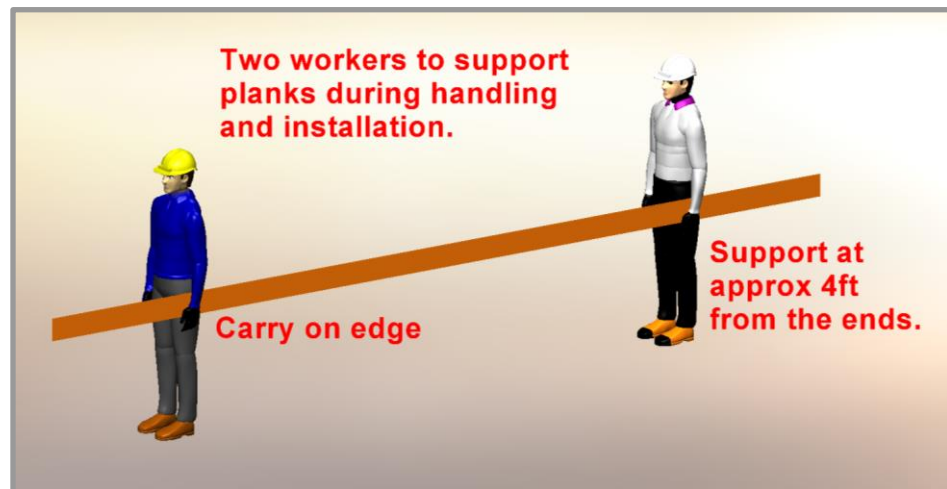
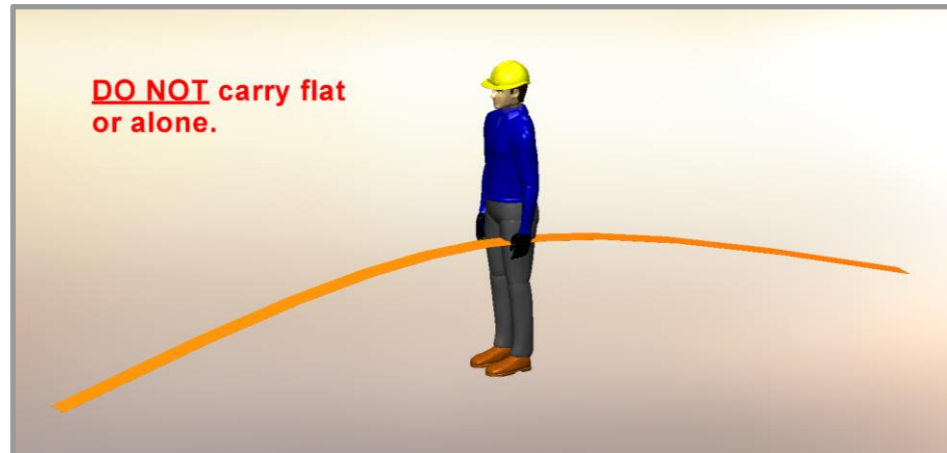

Delivery, Storage & Handling

- Always inspect the delivery for damage and contact LB ASAP if there are any issues: info@longboardproducts.com or 1-800-604-0343 and include your PO# and any pictures if possible. Longboard is not responsible for the installation of blemished or damaged material.
- Be sure to store the material flat, keep it dry, safe & secure and remain in unopened cartons until ready to be installed.
- Always wear appropriate PPE when handling products.

BLANK PAGE



Longboard Architectural Products Inc.
© Longboard Architectural Products Inc. All rights reserved.

Longboard® is a registered trademark of Longboard Architectural Products Inc.

Longboard
1777 Clearbrook Road
Abbotsford, BC V2T 8X8
Canada
longboardproducts.com

Every effort has been made to ensure that the information in these installation guidelines are accurate. Longboard is not responsible for printing or clerical errors.

For more information, contact client care at info@longboardproducts.com or call toll free 1-800-604-0343.